

## System Diagram

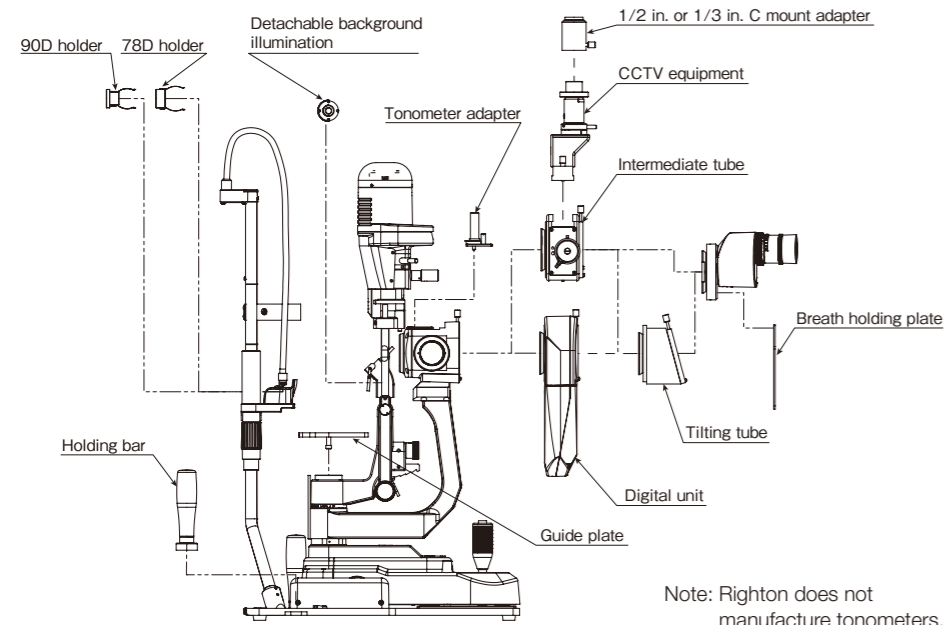

Note: Righton does not manufacture tonometers.

## Dimensions

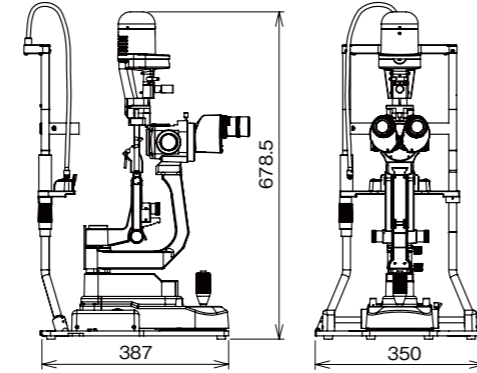

## Low power consumption and longer life

	Conventional halogen-lamp model	MW500 LED	
Power consumption	30W	5W	83% lower
Lifetime*	50 hours	60,000 hours (Lumen maintenance factor 70%)	12,000 times longer

\* Lifetime is the design life, and does not the lifetime of the lamp.

## Main Specifications of Righton LED Slit Lamp MW500D

Main body	
<b>Microscope</b>	
Type	Drum-type 5-step zoom (Angle of inclination: 13.2°)
Eyeiece magnification	12.5x
Total magnification	5x, 10x, 16x, 25x, 50x
Eyeiece diopter adjustment range	-8D to+8D
PD adjustment range	55 mm to 80 mm
Working distance	100.5 mm
Reaching distance	314.0 mm
<b>Illumination system</b>	
Light source	5W white LED
Slit width	0 mm to 16 mm continuously variable
Slit rotation angle	90° to right and left
Slit length	ø0.2, 1, 2, 5, 10, 14, 16 mm, 1 to 12 mm continuously variable
Slit vertical angle	0°, 5°, 10°, 15°, 20° from lower angle
Slit tilting width	8 mm to right and left from target surface
Filters	Fully transparent, ND (12.5% reduction), green, blue
<b>Arm unit</b>	
Rotation angle	90° to right and left
<b>Cross slide table</b>	
Horizontal movement	100 x 110 mm (joystick operation)
Vertical movement	30 mm (joystick rotation)
<b>Weight</b>	
Main body	13 kg (without digital unit) 13.8 kg (with digital unit)
<b>Dimensions</b>	350 (W) x 678.5 (H) x 387 (D) mm

Digital camera	
CCD	1/2.5" CMOS
Resolution	2592x1944 ppi resolution, 5-megapixel
Video image output	HD 1296x972 pixels
Frame rate	30 fps
Interface	USB3.0
Power supply	Input: 5V, Power consumption: 3W
Weight	790 g
Dimensions	107 (W) x 227 (H) x 55 (D) mm

Power unit	
Input	AC100V- 240V 50/60Hz
Output	DC12V / 3.75A (max.)
Power consumption	35VA
Weight	450 g
Dimensions	105 (W) x 48.5 (H) x 130 (D) mm

MW File	
<b>System</b>	
OS	Windows®7, 8.1, 10 / 64 bit
CPU	Intel Core i5, 1.5 GHz or more
Memory	2 GB or more
Interface	USB3.0 (1 port or more), or USB2.0 (1 port or more)
Monitor resolution	1366x768 pixels or more
Optical drive	DVD/CD drive
<b>Data storage</b>	
Still image	JPEG
Movie	AVI



### WARNING:

To ensure correct usage, read all manuals carefully before using equipment

Specifications and equipment are subject to change without any notice or obligation on the part of the manufacturer. © 2016 RIGHT MFG. CO., LTD. The information in this brochure is correct as of July 2016.



## MERCOFRAMES OPTICAL CORP.

© 5555 NW 74 AVE. Miami, FL 33166 [/mercoframes](https://www.mercoframes.com)  
 ✉ sales@mercoframes.net [www.mercoframes.com](http://www.mercoframes.com)  
 ☎ 305-882-0120 [www.mercoframesusa.com](https://www.mercoframesusa.com)

**Righton**

# LED Slit Lamp MW500D





# New MAGWIDE Slit Lamp

## Towards a revolution in super-wide magnification fine optics

- Employs a natural color LED light source with reduced blue that is perfect for slit images
- Wide magnification range enables both wide angle view and detailed observation
- All optics are multi-coated and provide a brighter viewing system with 22% higher transmittance than existing models.
- Slim body completely encloses cables

### Unique Mag Wide\* — ultra-wide magnification range

A newly-developed microscope with drum-type 5-step zoom and fine optics. A new optical system enables bright imaging even at 50x magnification. Drum-type zooming makes it easier to adjust the magnification within the wider range of 5x to 50x. All optics for observation are multi-coated to enable clear and high-resolution images. Extremely high quality optics promised.

**Magnifications:**  
5x (ø44.5), 10x (ø22.3), 16x (ø14.2), 25x (ø9.0), 50x (ø4.5)  
\* Mag Wide: a term coined from "magnification" and "wide"

### High field of view eyepiece

Wide field of view observation is possible even when wearing eyeglasses. Eyepieces can be fixed to the microscope tube to reduce gaps.

Diopter adjustment range: ±8D  
Eyereief: 19.2mm



### Background illumination

Background illumination is equipped in the arm unit as the standard. In addition to adjusting the brightness, the conveniently positioned illumination knob can turn the illumination on and off quickly and easily.

Detachable background illumination is also available as an option to allow the examiner to change lighting position.



### Built-in barrier filter

Simple slide operation makes it easy to insert and extract barrier filters. High contrast fluorescence images can be captured when a blue (exciter) filter is used.

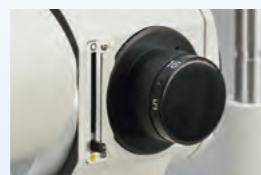

### Fixation lamp

The yellow-green LED fixation lamp is provided with an easy-to-use flexible arm.

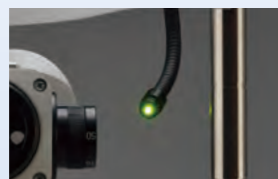

### 15° tilting tube (option)

15° tilting angle allows observation with a natural posture for taller users. Also possible to reduce the angle for shorter users.



### Convergence type eyepiece tube

The eyepiece tube converges at 8° from parallel optics for easy fusion, making more efficient, natural observation possible.



### High operability

A new plate is employed for stress-free smooth focus adjustment.



50X meibomian gland

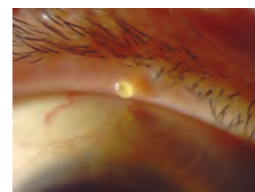

16X meibomian gland

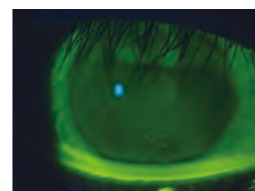

Fluorescence image

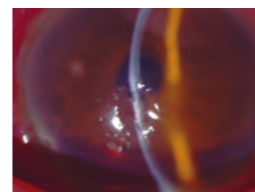

Cornea (background illumination on)

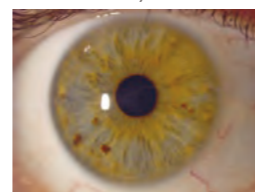

Iris (diffuse illumination)



Iris (tangential illumination)

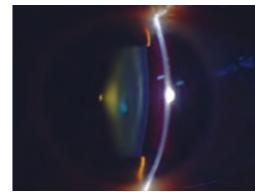

Crystalline lens

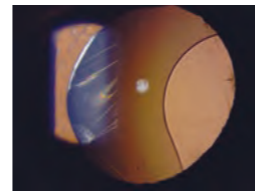

Transillumination

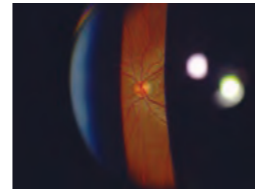

Disk (with 90D lens)

### Halogen color LED light source

An LED light source whose wavelength is much closer to a halogen lamp has been employed to give the slit lamp a bright, natural color. This eliminates the need for a filter to remove the common "bluish LED light" problem.

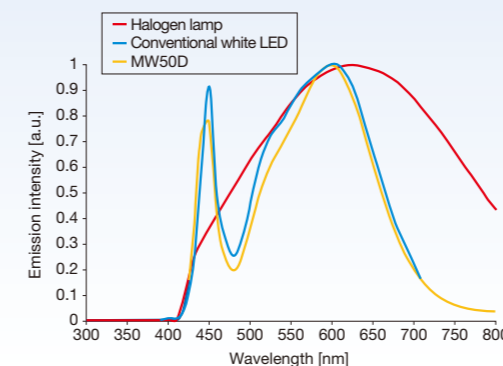

### Bright slit with sharp edges

The bright LED light source provides a slit with sharp edges and consistent lightning.

### A long 16mm slit tower height and filters

The 16mm slit tower height is compatible with a 5x wide view. The height can be adjusted in 7 steps (0.2mm, 1mm, 2mm, 5mm, 10mm, 14mm, 16mm) and enables seamless adjustment between 0mm to 12mm.

Fully transparent ND (12.5% reduction), green, blue, UV cut incorporated.

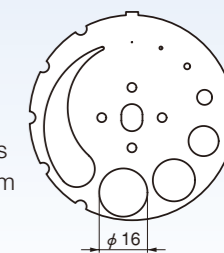

### Righton Digital Photo System

Both still images and movies can be captured with a simple joystick operation.

#### Righton Digital Camera

- 5M pixel wide dynamic range CMOS camera that reproduces natural colors
- Captures images at a high frame rate of 30 fps for smooth movies (Planning)
- By pressing the joystick button, the image is captured and saved automatically without needing to use a computer keyboard
- When the cross slide table is moved, the MW50D automatically detects right or left eye
- Beam-splitter ratio is 70% for camera and 30% for eyepiece
- Cables are housed in the MW50D body even when the camera is attached

#### IMAGE FILE MW File

- User-friendly, easy-to-view layout to suit wide monitors
  - Automatic bar code reading to speed up patient profile input process
  - 5 frame continuous imaging (Burst shot)
  - High-resolution live view and movie capturing at 1296 x 972 pixels
  - Enables black and white multi-band fundus photography
  - One set required for each camera
- \* Planning: Compatible with DICOM

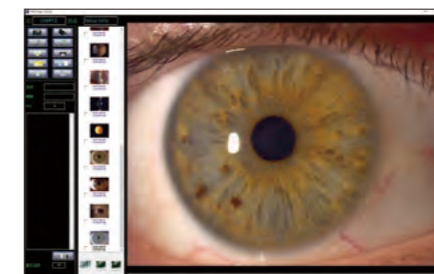

### Simple clinical set available



Chin rest adjustable for tall users, holding bar (Option)



For digital photography