

# HFC-009 PLUS Hand-held Fundus Camera

# Häns Heiss



**MERCOFRAMES**  
OPTICAL CORP

+1305-882-0120

5555 NW 74Av.

Miami, FL 33166

[sales@mercoframes.net](mailto:sales@mercoframes.net)

[www.mercoframes.com](http://www.mercoframes.com)

# Auto Split Focusing Technology

## Millisecond Focusing Speed

HFC-009 plus adopts Auto Split Focusing technology, focusing speed reaches milliseconds.

It avoids the out-of-focus of the fundus image caused by the patient's movement during shooting, effectively improve the image quality and reduce the requirements for cooperation between operators and patients.

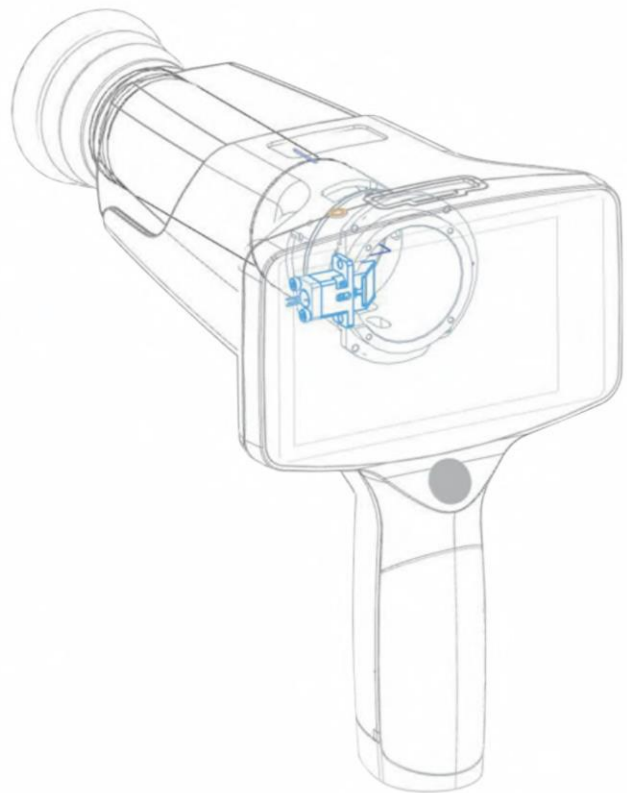
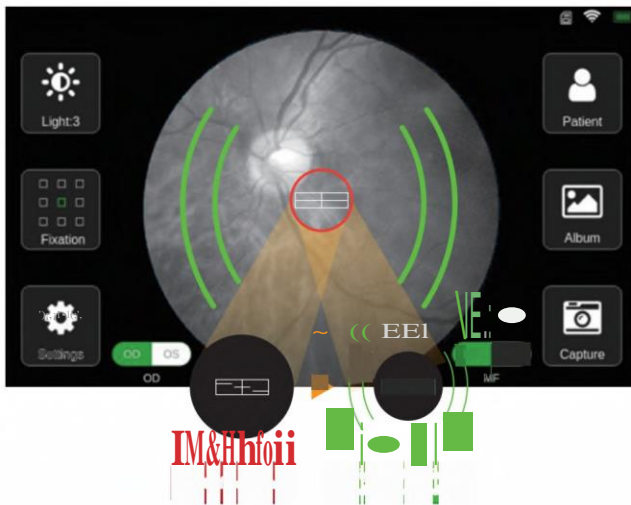

## Advantages

### High Resolution

HFC-009 Plus provides high resolution fundus images, image resolution is up to 12 Mega Pixels. It makes the diagnosis of early lesions more accurate and also essential for diagnosing retina disease, such as diabetic retinopathy, glaucoma and macular degeneration.

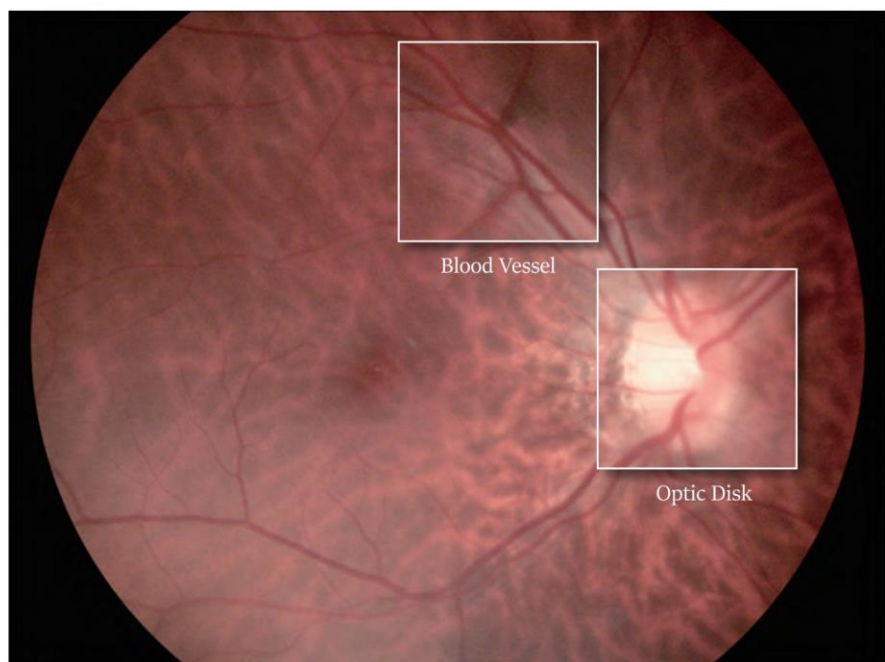

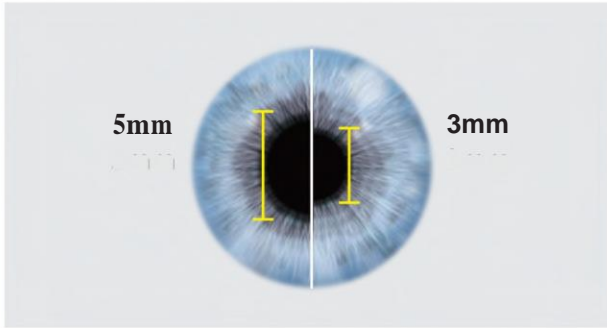

## Non-mydratic

The minimum pupil diameter of FC1fü is  $\phi 3.0\text{mm}$ . 20 minutes of mydratic waiting time is saved, and the risk of mydriasis to the patient is avoided.

## 9 Fixation Targets

With 9 fixation targets, FC161 covers 85° field of view of the fundus and supports the examination of early peripheral lesions of the fundus. With 45° field of view, a single central fundus image can be taken to meet the needs of fundus disease screening.

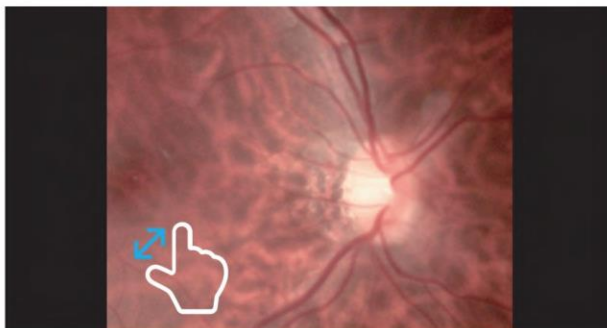
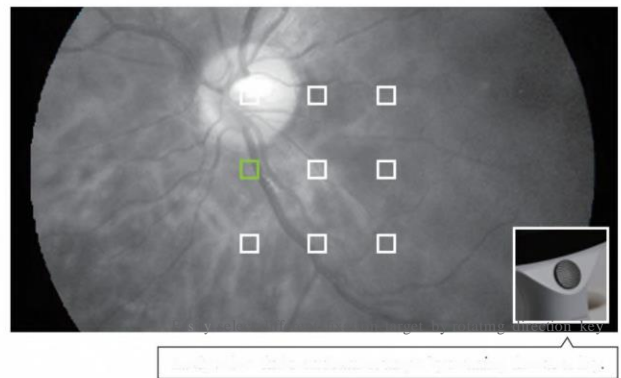

## Smart Touch Operation

4.3" full-touch LED screen brings a smarter operating experience. Doctors can zoom the image at any time to check the details of the fundus, and can also easily slide the screen to edit and view the case.

## Real-time Uploading

FC1fü supports real-time synchronization, software Wi-Fi

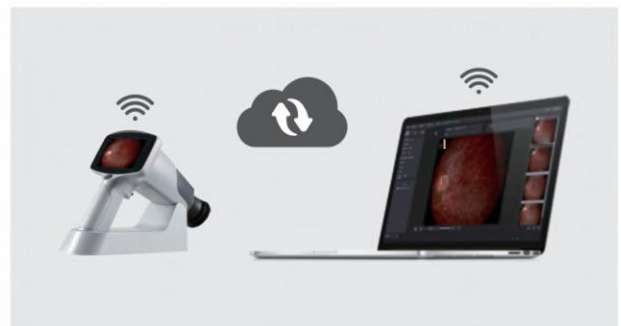









# Specification

Type	Non-mydriatric
Filed of View	45degrees
Camera Sensor Resolution	12M Pixels
Fixation Targets	9xLED,Internal
Minimum Pupil Size	3mm
Illumination	White LED & IR LED
Focusing	Manual/Automatic
Focus Range	-20D ~ +20D
Display	4.3" Touch Screen
Image Format	JPEG
Type of Image	Color
Memory	Micro SD card. Maximum 32G
Data Connectivity	WIFI/USB
Power Supply	Rechargeable battery 3.7V/3400mAh x 2
Working Time	3 hours of continuous work
Charging Station	100-240V ~, 0.SA, 50/60Hz
Power Supply	5V DC,2A
Dimensions	28cm x 13cmx 15cm
Weight	800g
languages	Chinese, English



## Standard Accessories

Standard Accessories

 Carrying Case	 Hand-held Fundus Camera	 Recharging Station	 Protection Cover	 Power Adaptor
 USB Cable	 SD Card	 Mediview Patient Management Software		

## Optional Accessories

Optional Accessories

 <b>SHT Lamp Attachment</b>	
--	---



**MERCOFRAMES** +1305-882-0120  
OPTICAL CORP

5555 NW 74Av.  
Miami, FL 33166

sales@mercoframes.net  
www.mercoframes.com