

# LensChek™ Plus/Pro Digital Lensometer®

## User's Guide



©2016 AMETEK, Inc.

Reichert, Reichert Technologies, and Lensometer are registered trademarks of Reichert, Inc.

LensChek is a trademark of Reichert, Inc,

AMETEK is a registered trademark of AMETEK, Inc.

All other trademarks are property of their respective owners.

The information contained in this document was accurate at time of publication. Specifications subject to change without notice. Reichert, Inc. reserves the right to make changes in the product described in this manual without notice and without incorporating those changes in any products already sold.

ISO 9001/13485 Certified – Reichert products are designed and manufactured under quality processes meeting ISO 9001/13485 requirements.

No part of this publication may be reproduced, stored in a retrieval system, or transmitted in any form or by any means, electronic, mechanical, recording, or otherwise, without the prior written permission of Reichert, Inc.

**Caution: Federal law restricts this device to sale by or on the order of a licensed physician. Rx only.**

# Table of Contents

Warnings and Cautions .....	4
Symbol Information.....	6
Introduction.....	7
Instrument Setup .....	8
Unpacking Instructions.....	8
Parts Identification.....	9
Initialization.....	11
Shutdown of Equipment .....	11
Measurement Screen.....	12
Description of Measurement Screen.....	12
Icons - Setup and Other Screens.....	13
Instrument Settings .....	14
Setup Screens .....	14
Practice Screen.....	17
Communication Settings .....	18
Time/Date Settings.....	19
Operation.....	20
Measurement Mode .....	20
Lens Placement .....	20
Single Lens .....	21
Framed Lens.....	22
Multifocal Lens .....	23
Progressive Lens .....	24
Contact Lens.....	27
UV Measurement - LensChek Pro .....	28
PD Measurement - LensChek Pro .....	28
Marking Lenses.....	29
Lenses With Astigmatism .....	29
Prism Lenses .....	30
Prism Lenses Measured in X-Y.....	30
Prism Lenses Measured in B-P.....	30
Lens Offset.....	30
Printing Patient Data .....	31
Cleaning & Maintenance .....	32
Cleaning .....	32
Main Unit.....	32
Nosepiece Lens .....	32
Printer Paper Replacement.....	32
Fuse Replacement .....	33
Storage.....	33
Power Cord Replacement .....	33
Marking Pen Replacement.....	34
Troubleshooting.....	35
Specifications .....	36
Guidance & Manufacturer's Declarations .....	38
Appendix.....	42
RS232C Connection.....	42
Warranty .....	43

# Warnings and Cautions

Reichert Technologies (Reichert) is not responsible for the safety and reliability of this instrument when:

- Assembly, disassembly, repair or modification is made by unauthorized dealers or persons.
- Instrument is not used in accordance with this User's Guide.

**WARNING: AN INSTRUCTION THAT DRAWS ATTENTION TO THE RISK OF INJURY OR DEATH.**



**WARNING:** DO NOT LOOK DIRECTLY INTO THE UV MEASUREMENT LENS AS IT MAY CAUSE PERMANENT EYE DAMAGE.

**WARNING:** UNITED STATES FEDERAL LAW REQUIRE THAT THIS DEVICE BE PURCHASED ONLY BY A PHYSICIAN OR A PERSON ACTING ON BEHALF OF A PHYSICIAN.

**WARNING:** THIS INSTRUMENT SHOULD BE USED IN STRICT ACCORDANCE WITH THE INSTRUCTIONS OUTLINED IN THIS USER'S GUIDE. THE SAFETY OF THE OPERATOR AND THE PERFORMANCE OF THE INSTRUMENT CANNOT BE GUARANTEED IF USED IN A MANNER NOT SPECIFIED BY REICHERT TECHNOLOGIES.

**WARNING:** DO NOT REPAIR OR SERVICE THIS INSTRUMENT WITHOUT AUTHORIZATION FROM THE MANUFACTURER. ANY REPAIR OR SERVICE TO THIS INSTRUMENT MUST BE PERFORMED BY EXPERIENCED PERSONNEL OR DEALERS WHO ARE TRAINED BY REICHERT OR SERIOUS INJURY TO THE OPERATOR MAY OCCUR.

**WARNING:** MODIFICATIONS TO THIS INSTRUMENT ARE NOT ALLOWED. ANY MODIFICATION TO THIS UNIT MUST BE AUTHORIZED BY REICHERT OR SERIOUS INJURY TO THE OPERATOR MAY OCCUR.

**WARNING:** IF THIS INSTRUMENT IS MODIFIED, APPROPRIATE INSPECTION AND TESTING MUST BE CONDUCTED TO ENSURE CONTINUED SAFE USE OF THIS INSTRUMENT.

**WARNING:** THE INTERNAL CIRCUITRY OF THE INSTRUMENT CONTAINS ELECTROSTATIC DISCHARGE SENSITIVE DEVICES (ESDS) THAT MAY BE SENSITIVE TO STATIC CHARGES PRODUCED BY THE HUMAN BODY. DO NOT REMOVE THE COVERS WITHOUT TAKING PROPER PRECAUTIONS.

**WARNING:** TO AVOID RISK OF ELECTRIC SHOCK, THIS EQUIPMENT MUST ONLY BE CONNECTED TO A SUPPLY MAINS WITH PROTECTIVE EARTH OR DAMAGE TO THIS INSTRUMENT AND/OR INJURY TO THE OPERATOR MAY OCCUR.

**WARNING:** ENSURE THAT THE VOLTAGE APPLIED TO THE UNIT IS THE SAME AS THE VOLTAGE THAT IS INDICATED ON THE DATA PLATE OR DAMAGE TO THE UNIT MAY OCCUR.

**WARNING:** THE INSTRUMENT MUST BE PLUGGED INTO AN OUTLET WITH AN EARTH GROUND. DO NOT REMOVE OR DEFEAT THE EARTH GROUND CONNECTION ON POWER INPUT CONNECTOR OR THE UNIT'S POWER CORD OF THIS INSTRUMENT OR DAMAGE TO IT AND/OR INJURY TO THE OPERATOR MAY OCCUR.

**WARNING:** THE EQUIPMENT OR SYSTEM SHOULD NOT BE USED ADJACENT TO OR STACKED WITH OTHER EQUIPMENT AND THAT IF ADJACENT OR STACKED USE IS NECESSARY, THE EQUIPMENT OR SYSTEM SHOULD BE OBSERVED TO VERIFY NORMAL OPERATION IN THE CONFIGURATION IN WHICH IT WILL BE USED.

**WARNING:** THIS INSTRUMENT IS NOT SUITABLE FOR USE IN THE PRESENCE OF FLAMMABLE ANESTHETIC MIXTURES, SUCH AS OXYGEN OR NITROUS OXIDE.

**WARNING:** THE USE OF ACCESSORIES OR CABLES OTHER THAN THOSE SPECIFIED, WITH THE EXCEPTION OF THOSE SOLD BY THE MANUFACTURER AS REPLACEMENT PARTS FOR THE INTERNAL COMPONENTS, MAY RESULT IN INCREASED EMISSIONS OR DECREASED IMMUNITY OF THE EQUIPMENT OR SYSTEM.

## Warnings and Cautions (continued)

**CAUTION:** AN INSTRUCTION THAT DRAWS ATTENTION TO THE RISK OF DAMAGE TO THE PRODUCT.



**CAUTION:** THE INTERNAL CIRCUITRY OF THE INSTRUMENT CONTAINS ELECTROSTATIC DISCHARGE SENSITIVE DEVICES (ESDS) THAT MAY BE SENSITIVE TO STATIC CHARGES PRODUCED BY THE HUMAN BODY. DO NOT REMOVE THE COVERS WITHOUT TAKING PROPER ESDS PRECAUTIONS.

**CAUTION:** DO NOT USE SOLVENTS OR STRONG CLEANING SOLUTIONS ON ANY PART OF THIS INSTRUMENT AS DAMAGE TO THE UNIT MAY OCCUR. SEE MAINTENANCE SECTION FOR DETAILED CLEANING INSTRUCTION.

**CAUTION:** USE OF AMMONIA BASED CLEANERS ON THE LIQUID CRYSTAL DISPLAY (LCD) MAY CAUSE DAMAGE TO THE DISPLAY. SEE MAINTENANCE SECTION FOR DETAILED CLEANING INSTRUCTION.

**CAUTION:** MEDICAL ELECTRONIC EQUIPMENT NEEDS SPECIAL PRECAUTIONS REGARDING EMC AND NEEDS TO BE INSTALLED AND PUT INTO SERVICE ACCORDING TO THE EMC INFORMATION PROVIDED IN THE ACCOMPANYING DOCUMENTS.

**CAUTION:** PORTABLE AND MOBILE RF COMMUNICATIONS EQUIPMENT CAN AFFECT MEDICAL ELECTRICAL EQUIPMENT.

**CAUTION:** THIS INSTRUMENT IS NOT TO BE USED NEAR HIGH-FREQUENCY EMITTING SURGICAL EQUIPMENT.

**CAUTION:** THIS INSTRUMENT IS NOT INTENDED TO BE CONNECTED TO EQUIPMENT OUTSIDE THE CONTROL OF REICHERT INC. OR MUST BE TESTED TO AN APPLICABLE IEC OR ISO STANDARDS.

**CAUTION:** DO NOT INSTALL ANY ADDITIONAL SOFTWARE OTHER THAN WHAT WAS SUPPLIED WITH THIS INSTRUMENT. INSTALLATION OF ADDITIONAL SOFTWARE MAY CAUSE UNEXPECTED OPERATION RESULTING IN MALFUNCTION OF THIS INSTRUMENT.

# Symbol Information



CAUTION



ON / OFF



Alternating Current - Indicates that this instrument operates on alternating current

**REF**

Catalog Number

**SN**

Serial Number



Date of Manufacture

YYYY-MM-DD



Manufacturer



Waste of Electrical and Electronic Equipment



Compliance with Electromagnetic Compatibility Directive 2014/30/EU and Low Voltage Directive 2014/35/EU



Consult Instructions for Use - Indicates that important operating and maintenance instructions are included in this User's Guide



Fragile Contents in Shipping Container - handle with care



Keep Dry - Package shall be kept away from rain



Authorized Representative in European Community



This Way Up - Indicates the correct upright position of package



Authorization to mark given by Intertek ETL Semko for compliance with electronic standards

# Introduction

Congratulations on your purchase of the Reichert Technologies® (hereafter referred to as Reichert®) LensChek™ Plus/Pro Digital Lensometer®.

The LensChek Plus/Pro will provide you with fast, accurate and reliable measurements of eyeglass lenses for many years. The instrument has an innovative microprocessor controlled lens measurement system that reduces operator error and provides precise, repetitive measurements for single, multifocal, and progressive lenses.

The LensChek Pro also allows you to take Pupillary Distance and Ultraviolet Light Transmittance measurements.

This User's Guide is designed as a training and reference manual for operation, maintenance, and troubleshooting. We recommend that you read it carefully prior to use and follow the instructions in the guide to ensure optimum performance of your new instrument. Properly trained eyecare professionals such as ophthalmologists, optometrists, opticians and eye care technicians should operate this instrument. All parts of this ME system are suitable for use within the patient environment.

**Note:** Words in all capital letters reference menu choices.

**Note:** Words in initial capital letters reference parts shown in the Parts Identification section of this manual. Also initial capitals are used when referencing menu options on the LCD Screen.

**Note:** Underlined words reference a specific section of this manual.

Please retain this guide for future reference and to share with other users. For additional copies of this manual or questions related to the LensChek Plus/Pro, contact your local authorized Reichert Technologies dealer or contact our Customer Service department directly at:

Tel: 716-686-4500

Fax: 716-686-4555

E-mail: reichert.information@ametech.com

## Indications for Use

The LensChek Plus is designed for:

- Measuring single, bifocal, and progressive eyeglass lenses.
- Measuring contact lenses.

The LensChek Pro is designed for:

- Measuring single, bifocal, and progressive eyeglass lenses.
- Measuring contact lenses.
- Measuring pupillary distance.
- Measuring lenses with ultraviolet transmittance.

## Contraindications

None.

# Instrument Setup

## Unpacking Instructions

The LensChek Plus/Pro and its accessories are packaged so as to protect them from damage during shipment. The outer box holds an inner box that contains the LensChek Plus/Pro instrument and an accessory box.

To unpack the LensChek Plus/Pro, follow these steps:

1. Cut the shipping straps and tape on the Outer Box to access the Inner Box. Refer to Figure SU-01.
  2. Remove the Foam Corners from the inside of the box. Refer to Figure SU-01.
  3. Cut the tape and Straps to access the contents of the Inner Box. Refer to Figure SU-02.
  4. Lift up the Cardboard Flaps from the Inner Box to access the unit. Refer to Figure SU-02.
  5. Remove the Accessory Box from the Inner Box. Refer to Figure SU-03.
  6. Carefully remove the LensChek Plus/Pro from the box and remove the protective cover that protects the instrument from dirt, contaminants and cosmetic damage. Refer to Figure SU-03.
  7. Remove the User's Guide from the bottom of the box.
  8. Remove the accessories from the Accessory Box. This box contains the following accessories:
    - Power cord\* - 120 V (P/N 16290-003) or Power cord\* - 230 V (P/N 15180-003)
    - Dust cover (P/N 15180-002)
    - Printer Paper (P/N 16290-006)
    - Contact Lens Stand (P/N 15180-004) (for measuring contact lenses.)
    - User's Guide (P/N 15180-101)
- Optional Accessories:
- RS232 Cable (10 ft) - (P/N 13912-409)
  - Wireless Dongle Kit - (P/N 15171)
  - Replacement Pens (Set of 3) - (P/N 15180-005)
  - Replacement Printer Paper (Pack of 5) - (P/N 12441)

**Note:** If any accessories are missing, please contact Reichert Technologies at the telephone numbers listed in the [Introduction](#) section of this manual.

**Note:** Place the packaging materials in a safe storage location in case you need to transport the unit.

**Note:** Please read the User's Guide before operating the LensChek Plus/Pro so that you will be familiar with its operation.

\* For other country requirements for cords, contact Reichert.

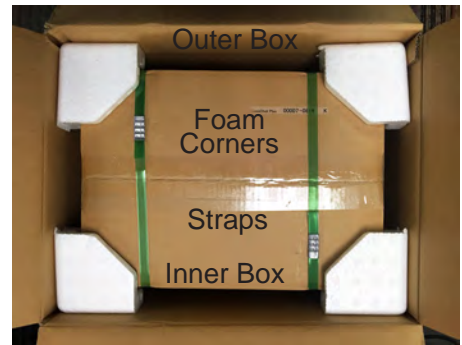

Figure SU-01 Outer Box Open

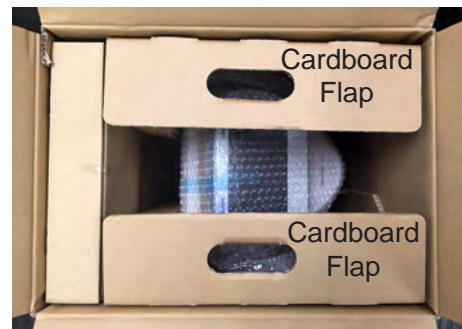

Figure SU-02 Inner Box Open



Figure SU-03 Inner Box Contents



Figure SU-04 Accessories



## Instrument Setup (continued)

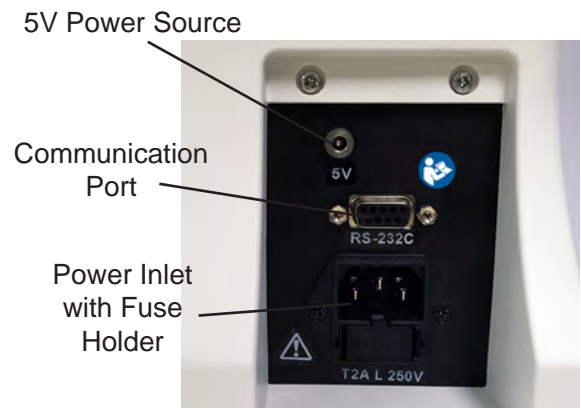

**Figure SU-05 LensChek Plus/Pro Front and Sides**

### Parts Identification

**LCD Screen:** Adjustable screen that can tilt up to 60°. Displays all measurements and functions.

**Power Indicator:** Green LED light that is illuminated when unit is turned ON. Light blinks when in power save mode.

**Lens Table:** This is pulled out when performing measurements so that a flat surface is available to hold the lenses or frames against while measuring and marking lenses.

**Nose Pads:** When measuring framed lenses, the right or left Nose Pad should be positioned in the middle of the frames to obtain a PD measurement. (LensChek Pro only.)

**Lens Stand:** Where the lens is placed in order to take a reading.

**Marking Lever/Lens Holder:** The marking lever and lens holder are integrated. The marking lever is pressed down to mark the lens, while the lens holder is lowered to secure the lens in place.

**Control Buttons:** Pressing these buttons activates/ selects the corresponding icon above them on the LCD Screen.

**Printer:** Prints out the measurement values.

**Memory/Add Button:** Stores the measurement values of the lens when pressed. When measuring a progressive lens in manual mode, this button is pressed to set the near and far points.

**Data Plate:** Displays the input power requirements, model name and number, serial number, and Reichert address. (Located on the back of the LCD Screen.)

**5V Power Source:** Connect the power cable for the Wireless Dongle Kit here.

**Communication Port:** Attach a cable here to send patient data to a computer.

**Power Inlet:** Attach the power cord here.

**Power Switch:** Use this switch to turn the LensChek Plus/Pro power ON and OFF.

## Instrument Setup (continued)

### Parts Identification (continued)

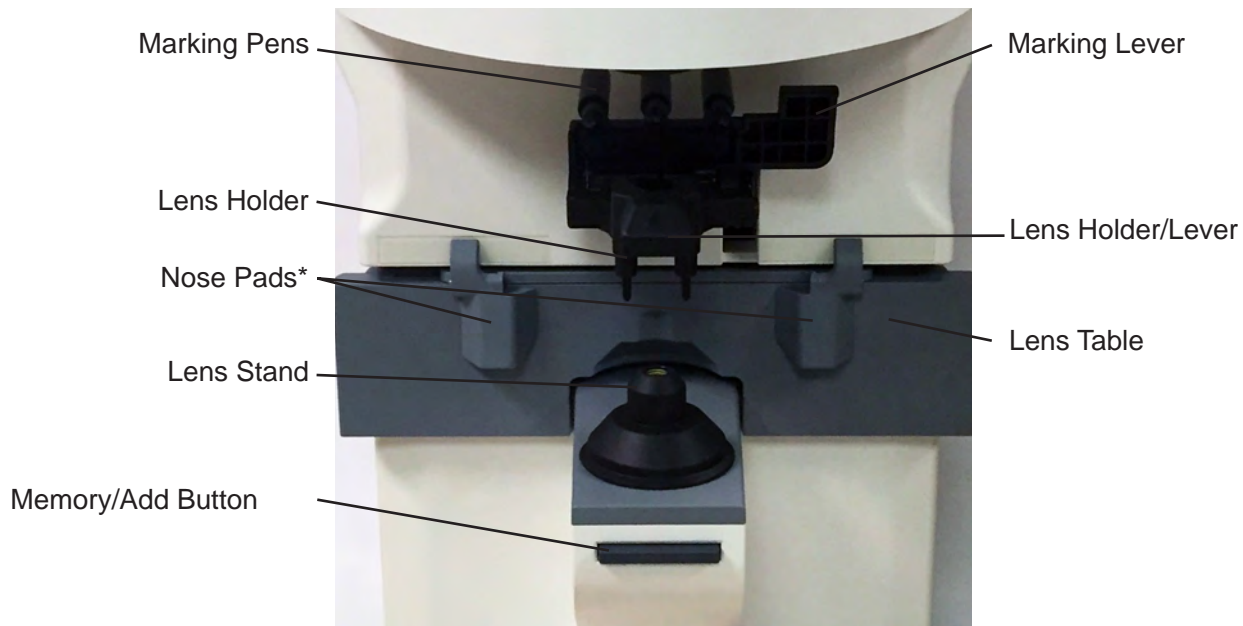

Figure SU-06 Measurement Area

**Lens Holder Lever:**

Use this lever to raise and lower the Lens Holder on the lens.

**Marking Lever:**

Use this lever to raise or lower the Marking Pens on the lens.

**Lens Holder:**

Secures the lens to the Lens Stand.

**Marking Pens:**

Use these pens to place ink marks on the lens.

**Lens Stand:**

Install this cover on the Nosepiece to measure eyeglass lenses.

**Contact Lens Cover:**

Install this cover on the Nosepiece to measure contact lenses. Refer to the [Contact Lens](#) section of this manual.

**Lens Table:**

Adjust this table against the bottom edge of the lens to help position it.

**Nose Pads:**

The Nose Pads allow for the automatic measurement of the Pupillary Distance (PD). (LensChek Pro only)

**Memory/Add Button:**

Press this button to manually store measurement values and to perform ADD measurements.

# Instrument Setup (continued)

## Initialization

**WARNING:** DO NOT APPLY INPUT POWER THAT EXCEEDS THE RATINGS GIVEN ON THE DATA PLATE, OR DAMAGE TO THE INSTRUMENT MAY OCCUR.

**WARNING:** CARE MUST BE TAKEN TO ARRANGE THE CABLES FOR THE ACCESSORIES SUCH THAT THEY DO NOT PRESENT A TRIPPING HAZARD TO THE OPERATOR.

**WARNING:** POSITION THIS INSTRUMENT SO THAT IT IS NOT DIFFICULT TO OPERATE THE DISCONNECTION DEVICE (PLUG).

Before turning on the power to the LensChek Plus/Pro, perform the following checks:

- Read the data plate located on the bottom of the instrument. Verify that the available input power to the LensChek Plus/Pro is within the listed voltage range.
- Connect the power cord to the LensChek Plus/Pro and then connect the other end to the power source.
- Set the Power switch to the ON position (pushed in on the “I” side).
- Check the operation of the Marking Pens. Verify that the pens do not block the optical path of the measuring system, which could generate an error message.
- Adjust the LCD Screen for the optimum viewing angle.
- Install the Printer Roller and the Printer Paper as indicated in the [Maintenance](#) section of this manual.

## Shutdown of Equipment

At any time, the power switch can be set to OFF. The unit does not have a power down sequence. To terminate operation of the LensChek Plus/Pro, press the ON / OFF switch to the OFF position (O).

# Instrument Setup (continued)

## Measurement Screen

### Description of Measurement Screen

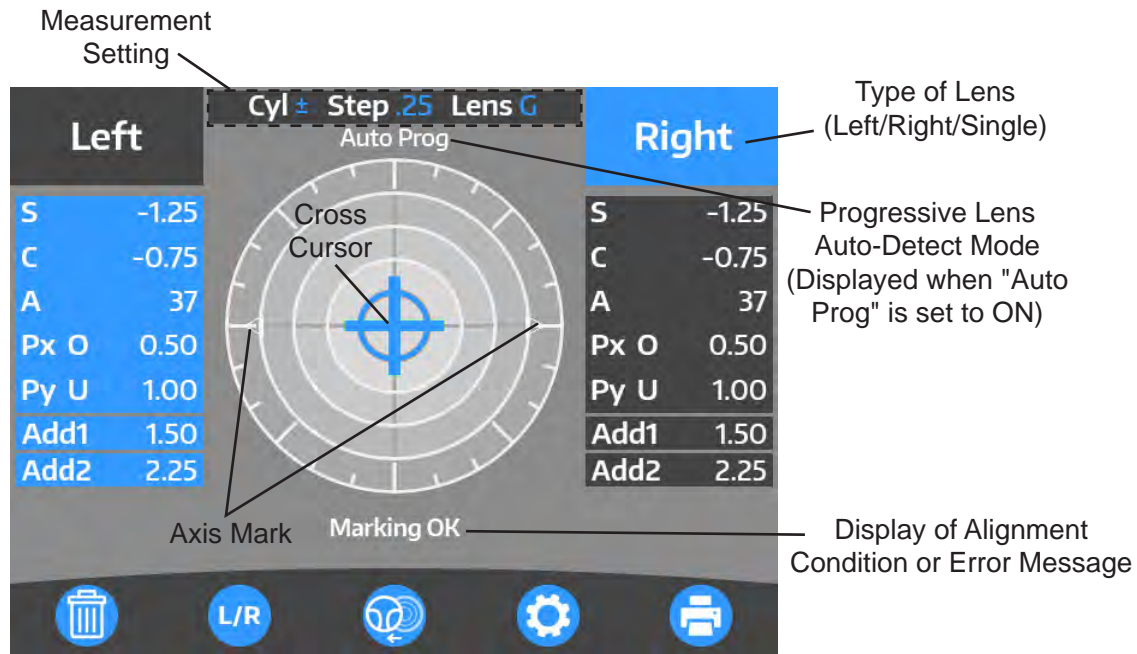

Figure SU-07 Measurement Screen

The functions of the buttons under the monitor correspond to the icons displayed at the bottom of the screen. At the time of normal measurement, they correspond to the icons shown below.



**Clear Icon:** Clears the measurement values. (The data stored in memory is also cleared by selecting this icon.)



**S/R/L,R/L Icon:** Selects single, left or right lens.



**Measurement Selection Icon:** Switches measurement mode from single vision lens to progressive lens.



**Setup Icon:** Switches to Setup screen.



**Print Icon:** Prints measurement results.



**Output Icon:** Outputs data from the RS232C port.



**Print and Output Icon:** Prints measurement results and outputs data from the RS232C port.

# Instrument Setup (continued)

## Icons - Setup and Other Screens

When you open the Setup Screen or the system screens, you will see the following icons for the control buttons. Refer to Figures SU-8 and SU-9.



**Down Icon** - Press this icon to move down the screen or go to a different page.



**Up Icon** - Select this icon to move up the screen or to a different page.



**Left Icon** - Select this icon to move left on the screen.



**Right Icon** - Select this icon to move right on the screen.



**Enter Icon** - Select this icon to enter a command or make a selection.



**Plus Icon** - Select this icon to increase a highlighted number on the screen.



**Minus Icon** - Select this icon to decrease a highlighted number on the screen.

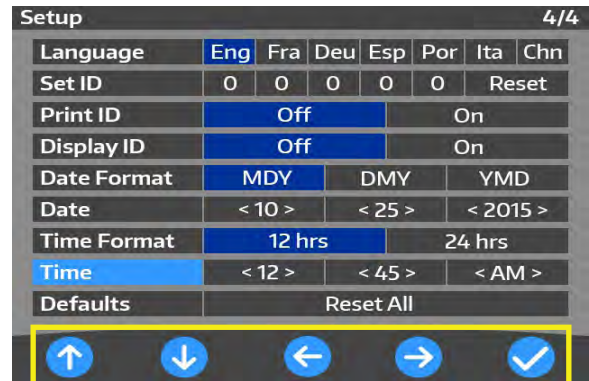

Figure SU-08 Control Button Icons for Setup screen

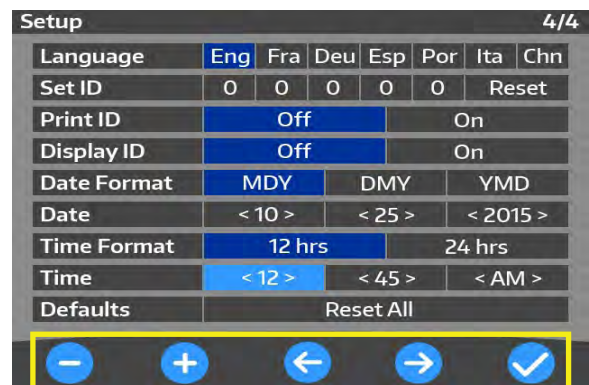

Figure SU-09 Control Button Icons for Date/Time Screen

# Instrument Setup (continued)

## Instrument Settings

### Setup Screens

The Setup Screens of the LensChek Plus/Pro displays four pages of default parameters that you can change to accommodate your preferences. The current default values are highlighted in blue. Refer to Figures SU-10, SU-11, SU-12, and SU-13.

Use the UP or DOWN icons to find a category, then use the RIGHT or LEFT icons to change the parameter in that category. You can then scroll to a different category and change that parameter.

When you are finished, select the ENTER icon (check mark icon) to save your changes and return to the previous screen.

The first page of the Setup Screen contains the following categories:



Figure SU-10 Page 1, Setup Screen

**Cyl** Selects sign for Cyl (- /+ / ±) (The sign set on the measurement screen is reflected here.)

**Step** Selects step to display measurement value (0.25 / 0.12 / 0.01)

**Auto Prog.** Sets auto detection of progressive lens (On / Off)

**Lens** Selects lens to be measured. (Glasses / H CL / S CL)  
Glasses: Framed lens  
H CL: Hard contact lens  
S CL: Soft contact lens

**Auto Memory** Automatically takes a reading when the lens is aligned. The measurements will be stored on the screen and "Marking OK" will appear, showing that the lens was read. (On / Off)

**Lens Switch** Sets lens switching function. (S/R/L / R/L)  
S/R/L: Single lens/ right lens/ left lens  
R/L: Right lens/ left lens

**ADD Measure** Selects auto/ manual memory of far and near points. (F/N.AT / N.AT / Manual)  
F/N.AT: Stores both near and far points automatically  
N.AT: Stores only near point automatically  
Manual: Stores data manually

**PD Measure\*** Displays the PD measurement (On / Off)

**UV Measure\*** Displays the UV measurement (On / Off)

\* These settings available with the LensChek Pro only.

# Instrument Setup (continued)

## Instrument Settings (continued)

### Setup Screens (continued)

The second page of the Setup Screen contains the following categories:

- Prism** Selects display of prism value and unit to be displayed. **(Off / X-Y / P-B)**  
Off: No display  
X-Y: X-Y display  
P-B: Prism value - base direction.
- Prism(mm)** Displays the offset from the optical center in mm **(On / Off)**
- Abbe** Selects Abbe number. **(20 / 30 / 40 / 50 / 60)**
- Ray** Selects measurement wavelength. **(e / d)**  
e: measures the e line  
d: measures the d line
- Output Device** Select where the measurement data will go. **(Printer / RS232C / Both)**
- Auto Comm** Set to either continuously send data to comm port or not. **(Off / On)**
- Baud Rate** Select the baud rate. **(115200 / 38400 / 9600)**
- Prog. Graph** Sets display of ADD value and assessment graph on progressive lens measurement screen. **(On / Off)**
- Graph Print** Sets printing of ADD value and assessment graph after measuring progressive lens. **(On / Off)**

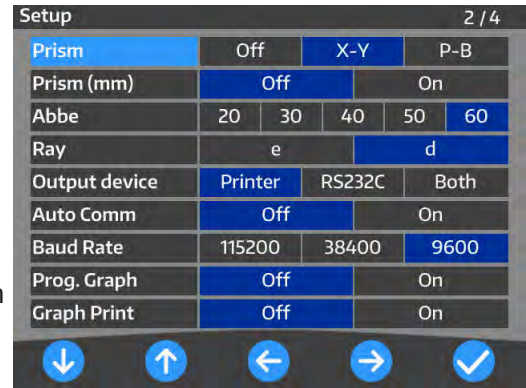

Figure SU-11 Page 2, Setup Screen

The third page of the Setup Screen contains the following categories:

- Practice** Input the Practice Name as it will appear on printouts. **(Enter Data)**
- Set ID#** Sets the starting point for the Patient Identification Number (up to 5 digits).
- Print ID#** Display the Patient ID on the printout. **(Off / On)**
- Display ID#** Display the Patient ID on the screen. **(Off / On)**
- Date Format** Select how the date is displayed. **(MDY / DMY / YMD)**
- Date** Set the current date.
- Time Format** Display the time in either 12 hour or 24 hour format. **(12hrs / 24hrs)**
- Time** Set the current time.

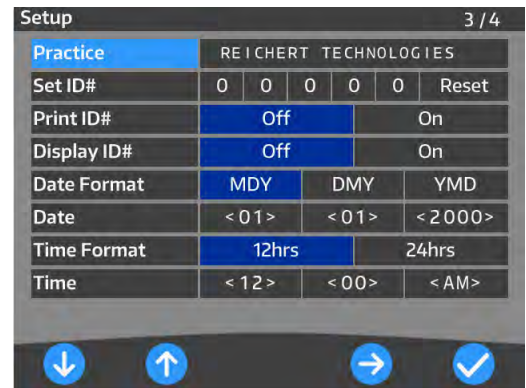

Figure SU-12 Page 3, Setup Screen

# Instrument Setup (continued)

## Instrument Settings (continued)

### Setup Screens (continued)

The fourth page of the Setup Screen contains the following categories:

**Brightness** Sets brightness of screen  
**(7 Preset Settings)**

**Sleep** Selects time to activate sleep mode  
**(Off / 3min / 5min / 10min)**

**Note:** When the unit goes into sleep mode, the power light will blink. This is to indicate it is in sleep mode. Pressing any button will wake up the unit and turn it back on.

**Tone** Enables an audible tone to sound when pressing the buttons. **(Off / On)**

**Language** Selects language displayed on screen  
**(Eng / Fra / Deu / Esp / Por / Ita / Chinese)**

**Defaults** Highlight Reset All and press the Enter icon to change all settings back to defaults.  
**(Reset All)**



Figure SU-13 Page 4, Setup Screen



# Instrument Setup (continued)

## Instrument Settings (continued)

### Practice Screen

The Practice Screen allows you to enter a business name or other message that will automatically print with the patient data.

#### Creating a Message

1. On the Practice ID screen, press the blue UP, DOWN, RIGHT, or LEFT icons to highlight the character that you want to appear in the text box.
2. Select the ENTER icon. The selected character will appear in the text box. Refer to Figure SU-14.
3. Repeat Step 1 and 2 until you finish your message.
4. When you are finished, highlight DONE and select the ENTER icon to save your message and return to the Setup Screen.
5. This Practice ID will now print out with the patient data when you select YES under Display ID# in the Setup Screen.

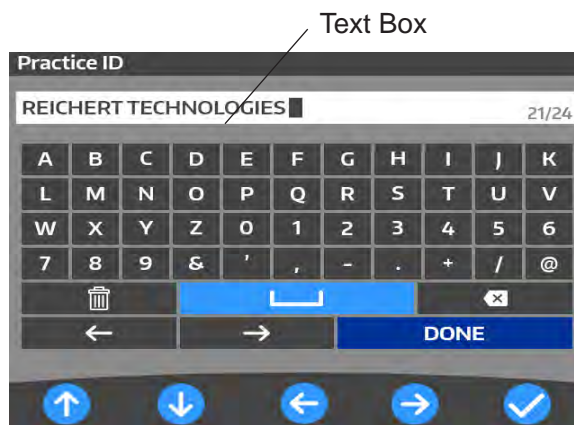

Figure SU-14 ID Screen

#### Editing Characters in a Message

1. On the Practice ID screen, use the left and right arrow icons in the main selection area, to highlight the character *in front of* the character you want to change in the text box.
2. Use the UP, DOWN, RIGHT, or LEFT icons to highlight a replacement character from the grid, then select the ENTER icon. The character will be inserted *behind* the highlighted letter. Refer to Figure SU-13.
3. Repeat steps 1 and 2 for each character that needs to be changed.

#### Deleting Characters in a Message

1. On the Practice Screen, use the LEFT, RIGHT, UP, or DOWN icons to highlight the character *in front of* the character that needs to be deleted. Select the CLEAR icon, located above the DONE icon.
2. To erase the entire message and start from the beginning, use the UP, DOWN, RIGHT, or LEFT buttons to highlight the CLEAR icon, and select it. The entire message will be deleted.

# Instrument Setup (continued)

## Instrument Settings (continued)

### Communication Settings

Page 2 of the Setup menu allows you to set the communication parameters for outputting the measurement values to an external device.

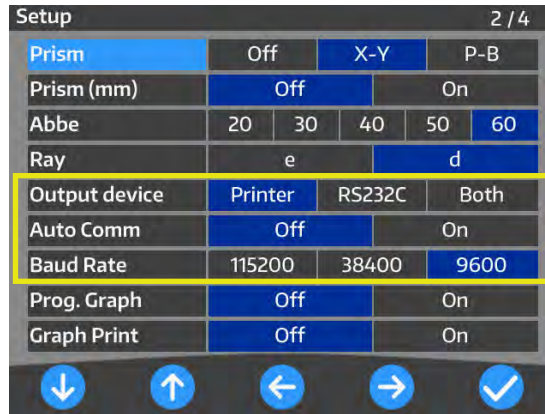

Figure SU-15 Communication Screen

The measurement values are output by selecting “RS232C” or “Both” in the "Output Device" section on page 2 of the Setup screen.

**Note:** The output content is same as that of the printout. However, the progressive lens graph is not outputted.

**Output Device: Printer:** Enables the LensChek Plus/Pro printer. If you press the Printer Icon on the LCD Screen, the patient data goes to the LensChek Plus/Pro printer.

**RS232C:** Enables the RS232C port. If you press the TRANSFER icon on the LCD Screen, the patient data goes to your computer.

**Both:** Enables the data to both be transferred to the RS232C port as well as print the measurement data.

**Auto Comm: OFF:** Disables Auto Communication.

**ON:** Enables Auto Communication, which continuously sends patient data to the computer.

**Baud Rate:** Select a Baud rate of 115200, 38400, or 9600.

**Note:** If you set “Output Device” to “Printer”, it will disable the Auto Communication feature.

**Note:** To view the RS232C wiring interface protocol, refer to the [Appendix](#) section of this manual.

# Instrument Setup (continued)

## Instrument Settings (continued)

### Time/Date Settings

The Date/Time settings allow you to enter the correct time and date for your patient printout and to change the date and time format.

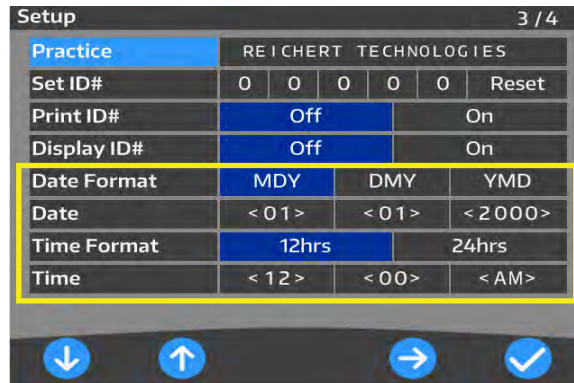

Figure SU-16 Date/Time Screen

1. To change the Date Format, press the UP or DOWN arrows to reach the Date Format field. Press the RIGHT or LEFT buttons to select a date format. Refer to Figure SU-15.

Your options include:

- M/D/Y - Month, Date, Year
- D/M/Y - Date, Month, Year
- Y/M/D - Year, Month, Date

2. To change the current date, press the RIGHT or LEFT arrows in the Date field to highlight the date values (month, day, or year) you want to change. Some of the icons at the bottom of the screen will change.
3. Press the PLUS (+) or MINUS (-) buttons to change the date values.
4. To change the Time Format, press the UP or DOWN arrows to reach the Time Format field. Press the RIGHT or LEFT buttons to select a time format. Refer to Figure SU-16.
5. Your options include:
  - 12hrs - Displays the time in AM or PM.
  - 24hrs - Displays the time in 24 hour format.
6. To change the current Time, press the RIGHT or LEFT arrows in the Time field to highlight the time values (hours or minutes) you want to change. Some of the icons at the bottom of the screen will change.
7. Press the PLUS (+) or MINUS (-) buttons to change the values.

### Defaults

This setup section changes the setting of the device back to the default. Using the RIGHT and LEFT arrows, highlight RESET ALL if you wish to change the setting back to the default. Press the RETURN icon. A long tone will sound, indicating the device has been set back to the default settings. Press the Enter icon to exit the Setup screen.

# Operation

## Measurement Mode

The LensChek Plus/Pro allows you to measure single lenses and framed lenses; bifocal, multifocal, and progressive lenses. You can also take prism measurements.

The LensChek Pro allows you to perform pupillary distance (PD) measurements, and check the ultraviolet (UV) light transmittance.

**Note:** Before you measure a lens, verify that the instrument lens under the Lens Stand is clean. Use a lens cleaning cloth or a soft, dry, clean cotton cloth to clean it.

**Note:** For instructions on using the Marking Pens, refer to the [Marking Lenses](#) section of this manual.

**Note:** For instructions on placing and measuring contact lenses, refer to the [Contact Lens](#) section of this manual.

## Lens Placement

1. Place the lens (oriented up) on the top of the Lens Stand, with the bottom edge of the lens facing the Lens Table. Refer to Figure OP-1.
2. Pull the Lens Table towards the lens so that it touches the bottom edge of the lens. This ensures a correct axis orientation.
3. Raise and then lower the Lens Holder Lever to secure the lens to the Lens Stand.
4. When you are finished, raise the Lens Holder Lever to release the lens.



**Figure OP-01 Place Lens on Lens Stand**

# Operation

## Measurement Mode (continued)

### Single Lens

1. Place the lens on the lens stand.
2. Lower the lens holder softly on the lens. The screen as shown in Figure OP-2 appears.

**Note:** Do not suddenly drop the lens holder on the lens when lowering the lens holder. Gently lower the lens holder until it contacts the lens. When raising the lens holder, make sure that it is moved to the top and locked in place, until you hear a click sound.

3. Center the green Cross Cursor mark by moving the lens. The message “Alignment OK” will appear on the screen when the lens is aligned properly.

**Note:** If measuring a cylinder lens, rotate the lens to fit the axis direction.

**Note:** The Alignment Mark represents the optical center of the lensmeter and the Cross Cursor represents the optical center of the lens.

4. Press the Memory/Add button to store the Sphere, Cylinder, Axis and Prism measurements.

**Note:** If “Auto Memory” in the Setup screen is set to “On”, then the lens will automatically be measured once the Cross Cursor is centered in the middle of the Alignment Mark.

**Note:** When the center is found, either automatically or by pressing the Memory/Add button, the Cross Cursor will change from green to blue, and the measurement box will change from gray to blue.

5. When finished, print, transfer or clear the data by pressing the corresponding button.



Figure OP-02 Single Lens

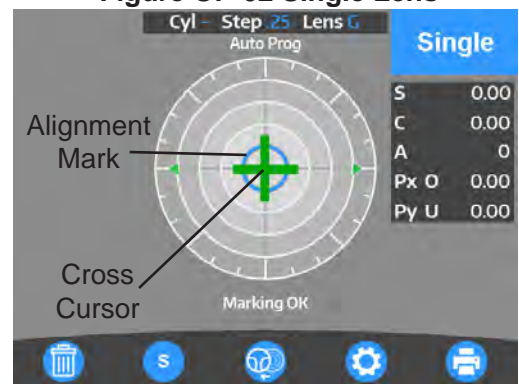

Figure OP-03 Alignment



Figure OP-04 Marking OK

# Operation (continued)

## Measurement Mode (continued)

### Framed Lens

1. Place the framed lens on the lens stand and lower the lens holder softly on the lens.
2. Pull out the lens table so that the bottom of the lens touches the lens table.
3. If framed lenses are not already selected, specify framed lenses by pressing the **S** button. It will switch to **L/R**.

**Note:** Each time you press the **L/R** button it will toggle between the left and right lens. The active lens will appear in blue. The inactive lens will appear in gray.

4. Align the lens by centering the green Cross Cursor mark in the center of the target by moving the lens. The message “Marking OK” will appear on the screen when the lens is aligned properly. Refer to Figure OP-06.

**Note:** The Alignment Mark represents the optical center of the lensmeter and the Cross Cursor represents the optical center of the lens.

5. Press the Memory/Add button to store the Sphere, Cylinder, Axis and Prism measurements. Refer to Figure OP-07.

**Note:** If “Auto Memory” in the Setup screen is set to “On”, then the lens will automatically be measured once the Cross Cursor is centered in the middle of the Alignment Mark.

**Note:** When the optical center is found, either automatically or by pressing the Memory/Add button, the Cross Cursor will change from green to blue, and the measurement box will change from gray to blue. Refer to Figures OP-06 and OP-07.

6. To measure the other lens, select the opposite lens by pressing the **L/R** button and follow the above procedure to measure the other lens.

**Note:** Once the measurements have been stored for a lens, the measurement values will remain on the screen when toggling back and forth. Saved data will always appear in a blue box.

7. When finished, print, transfer or clear the data by pressing the corresponding button.



Figure OP-05 Right Lens

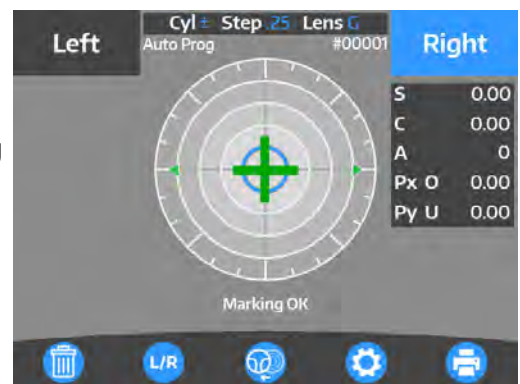

Figure OP-06 Align Right Lens



Figure OP-07 Measurement Stored



Figure OP-08 Measure Left Lens

# Operation (continued)

## Measurement Mode (continued)

### Multifocal Lens

1. Measure the far point by aligning the lens by centering the green Cross Cursor mark in the center of the target by moving the lens. The message "Alignment OK" will appear on the screen when the lens is aligned properly.
2. Press the Memory/Add button to store the Sphere, Cylinder, Axis and Prism measurements.

**Note:** If "Auto Memory" in the Setup screen is set to "On", then the lens will automatically be measured once the Cross Cursor is centered in the middle of the Alignment Mark.

**Note:** When the optical center is found, either automatically or by pressing the Memory/Add button, the Cross Cursor will change from green to blue, and the measurement box will change from gray to blue. Refer to Figure OP-10.

3. To take a measurement of the Near Point, press the Measurement/Add button. "Add1" will appear in gray beneath the stored values. Refer to Figure OP-10
4. Take a measurement of near point by moving the lens so that the near point (near-sight segment) comes to the center of the lens stand.

**Note:** A measurement can be taken even if the messages "Alignment OK" and "Marking OK" are not displayed.

5. Store the ADD value of the near point (near-sight segment) in memory by pressing the Memory/Add button. The gray "Add1" box will change from gray to blue, indicating the value is stored. Refer to Figure OP-11.

**Note:** If a trifocal lens is being measured, press the Measurement/Add button again and "Add2" will be displayed in gray, indicating the unit is ready to measure the second segment. Once the second segment is aligned, press the Memory/Add button to save the measurement. The "Add2" box will change from gray to blue, indicating the measurement is stored. Refer to Figure OP-12.

6. Switch to the left lens by pressing L/R.
7. At this time, the measurement result of the right lens remains on the screen.

**Note:** The active lens being measured ("LEFT" or "RIGHT") will be displayed in blue, and the inactive lens will be displayed in gray.



Figure OP-09 Align Right Lens



Figure OP-10 Nearpoint Alignment

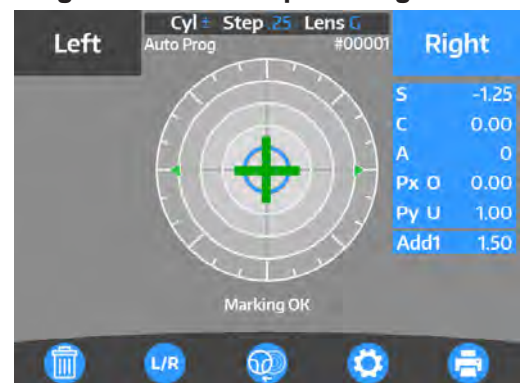

Figure OP-11 Add Value Stored

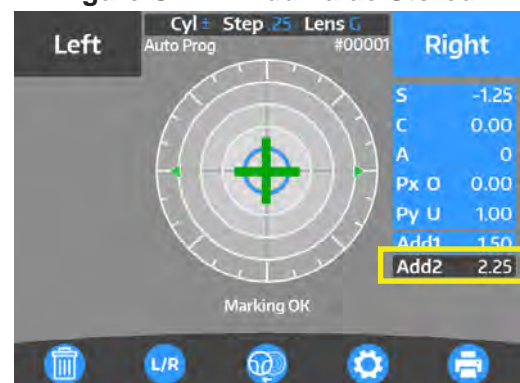

Figure OP-12 Trifocal Point

# Operation (continued)

## Measurement Mode (continued)

### Progressive Lens

1. Set the “Auto Prog.” and “ADD Measure” preferences in the Setup Menu. Refer to Figure OP-13.

#### Set Auto Prog.

**Off:** Unit will not automatically determine if a progressive lens is being measured, and will remain in single/left/right mode.

**On:** Unit will automatically determine if a progressive lens is being measured, and switch to progressive mode.

**Note:** If Auto Prog is set to “On”, the lens is automatically judged whether the lens is a progressive lens or not. If “Auto Prog.” is “On”, it is indicated on the measurement screen of the single focus lens.

**Note:** When a lens is placed with the near point facing the Lens Table, the LensChek Plus/Pro will determine if it is a progressive lens or not. Refer to Figure OP-14. Once the lens is identified as a progressive lens, the screen will automatically switch to the progressive lens measurement screen. If not, the measurement screen remains in single focus lens mode. Select the Progressive Icon to switch to the progressive measurement screen. Refer to Figure OP-15.

**Note:** If the lens is placed with the far point facing the Lens Stand, then the unit will **NOT** be able to detect the progressive lens.

**Note:** If the ADD value is small, the unit may not automatically detect the progressive lens.

#### Set ADD Measure

**F/N.AT:** Automatically measures the far and near points

**N.AT:** Automatically measures the near point

**Manual:** Manually measures the far and near points

**Note:** If the lens is dirty or has some flaws, the far point and near point may not be automatically measured, and manual measurements may be necessary,

2. If the unit does not automatically detect a progressive lens, switch to progressive mode by pressing the  button. Refer to Figure OP-15.
3. The screen in Figure OP-16 will appear once progressive mode has been activated or selected.

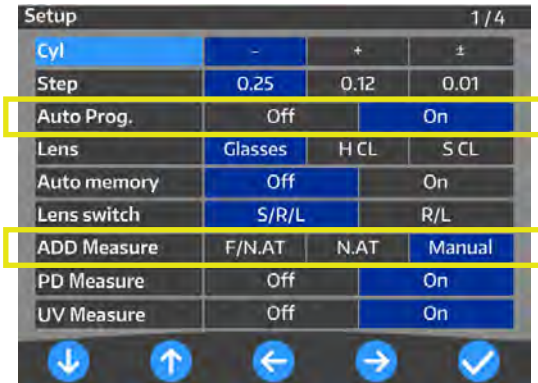

Figure OP-13 Page 1, Setup Screen



Figure OP-14 Proper Orientation

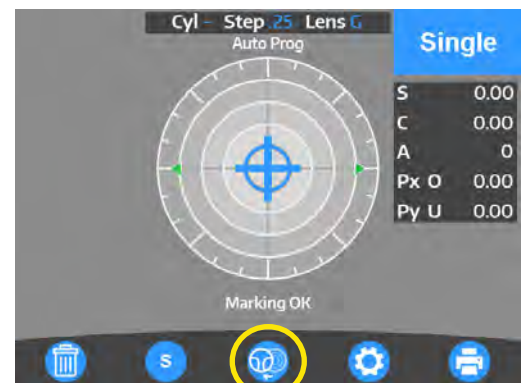

Figure OP-15 Progressive Icon

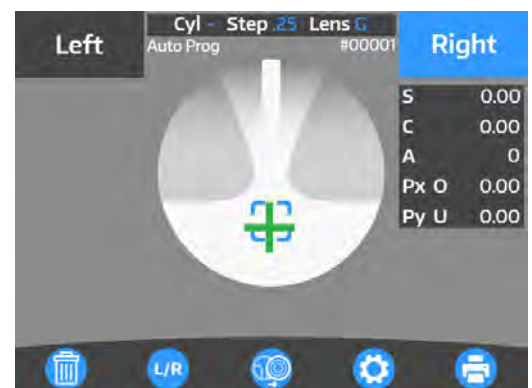

Figure OP-16 Align Near Point



# Operation (continued)

## Measurement Mode (continued)

### Progressive Lens(continued)

#### Measuring a Progressive Lens

If the Near and/or Far points are set to be automatically measured (F/N.AT, N.AT) the measurements will be automatically saved when the lens is properly aligned. If the progressive lens is set to be measured manually, then the Measurement/Add button must be pressed to save the values after the lens is aligned.

1. Find the progressive zone by moving the lens from left to right, and front to back, *slowly*. The green cross cursor appears when the progressive zone is found. Refer to Figure OP-17.

**Note:** If the unit does not automatically detect a progressive lens because the ADD value is small, switch to progressive mode by pressing the  button.

2. Take a measurement of far point by moving the lens so that the center of the alignment mark overlaps with the cross cursor.

**Note:** The cross cursor will change from green to blue, and the gray box will turn blue, indicating the values are saved. Refer to Figure OP-18.

3. Take a measurement of near point by moving the lens slowly, so that the green cross cursor is moving towards the near point.

**Note:** When the lens is centered, a green arrow will appear, indicating the direction the lens should be moving in. Refer to Figure OP-19.

**Note:** If the arrow disappears, it means the lens has moved outside of the progressive zone. Slowly move the lens left or right, until the arrow appears again, indicating it is centered.

4. While slowly approaching the near point, the green arrow will start to blink, indicating it is close to the near point. Once the near point is detected, it will make a sound. The cross cursor will change from green to blue, indicating the near point value is saved. Refer to Figure OP-20.

**Note:** Another ADD value (Add2) can be stored in memory anywhere by pressing the Memory/Add button after measurement.

-continued-

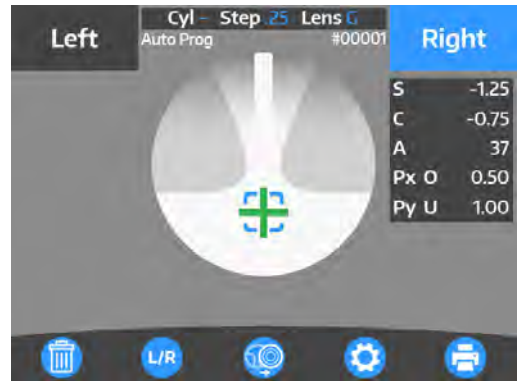

Figure OP-17 Progressive Lens

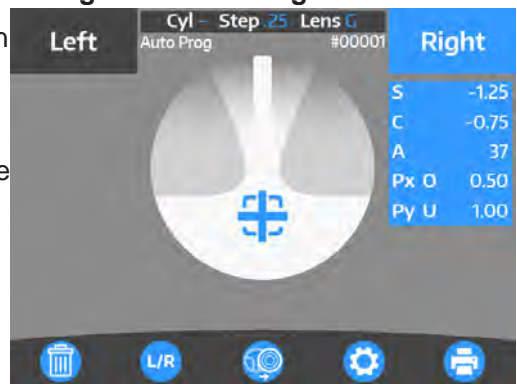

Figure OP-18 Align Lens

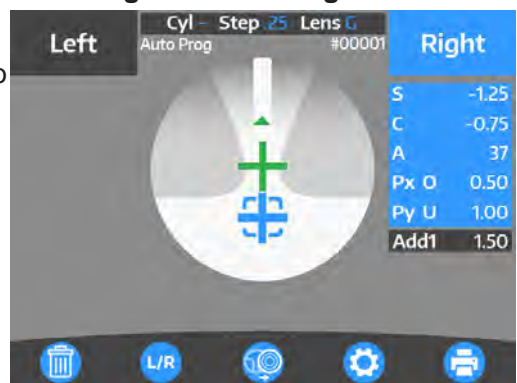

Figure OP-19 Find Far Point

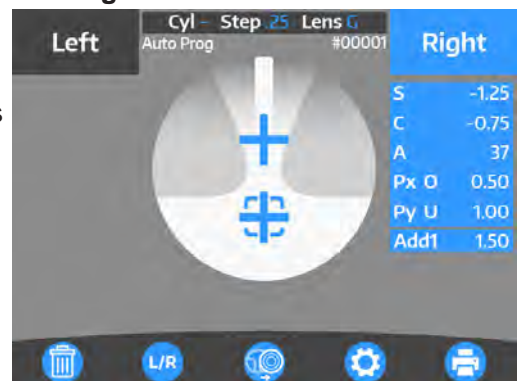

Figure OP-20 Store Values

# Operation (continued)

## Measurement Mode (continued)

### Progressive Lens(continued)

#### Measuring a Progressive Lens (continued)

5. To switch to the opposite lens, press the **L/R** button to select the opposite lens.
6. Take a measurement of the opposite lens in the same way.

**Note:** Measurements can be started from either right or left lens.

**Note:** To clear the stored data in the current lens, press CLEAR.

#### Assessment Graph and Manual Operation

Depending on the type of lens, it may be difficult to detect each point automatically even though normally the near and far points are measured automatically and stored. When a lens is difficult to automatically measure, manual measurements will need to be taken. Referencing the assessment graph can help with determining the near and far points. To take a measurement of far point manually, perform the same steps described in the **Measuring Progressive Lenses** section of this manual.

1. In the Setup Menu, set “Prog. Graph” to “On”, to display the progressive lens graph on the measurement screen.
2. Take a measurement of far point by moving the lens so that the center of the alignment mark overlaps with the cross cursor. Press the Measurement/Start button to take the measurement.
3. Measure the near point, by slowly moving the lens towards the nearpoint.

**Note:** The Add Value and Assessment Lines will slowly grow as the lens is moved towards the near point. Once you reach the near point, the Assessment Line will curve back towards the Add Value Line. Once it crosses the Add Value Line, you have reached the near point. Press the Measurement/Start button to save the near point value. Refer to Figure OP-21.

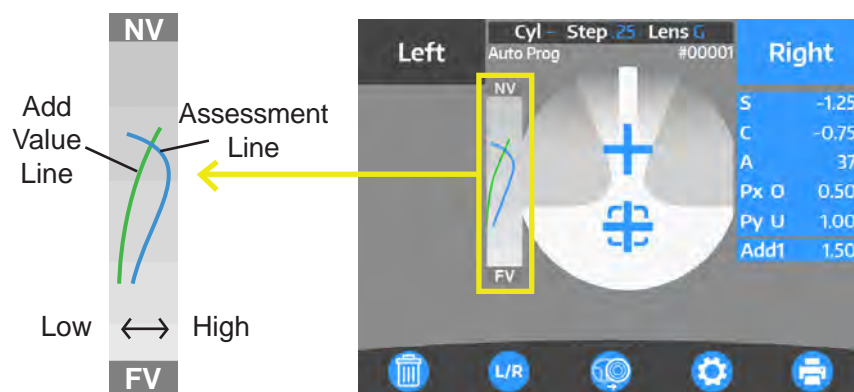

Figure OP-21 Progressive Graph

## Operation (continued)

### Measurement Mode (continued)

#### Contact Lens

The procedure for measuring a contact lens is identical to measuring framed lenses, however the correct contact lens type must be selected in the Setup menu (either hard or soft contacts) and the lens stand must be replaced with the contact lens stand.

1. To measure hard contact lenses, select “H CL” in the Setup menu. To measure soft contact lenses, select “S CL” in the Setup menu.
2. Change the lens stand from the standard lens stand to the contact lens stand. Refer to Figure OP-22.
3. Place the contact lens on the contact lens stand.

**Note:** Remove the water or moisture from the lens, and set it on the stand, being careful not to distort it. Take the measurement quickly.

**Note:** A bifocal contact lens cannot be measured.

4. Holding the contact lens stand, lower the lens holder.
5. Center the green Cross Cursor mark by moving the lens. Refer to Figure OP-23.
6. The message “Alignment OK” will appear on the screen when the lens is aligned properly. Refer to Figure OP-24.

**Note:** The Alignment Mark represents the optical center of the lensmeter and the Cross Cursor represents the optical center of the lens.

7. Press the Memory/Add button to store the Sphere, Cylinder, Axis and Prism measurements.

**Note:** If “Auto Memory” in the Setup screen is set to “On”, then the lens will automatically be measured once the Cross Cursor is centered in the middle of the Alignment Mark.

**Note:** When the optical center is found, either automatically or by pressing the Memory/Add button, the Cross Cursor will change from green to blue, and the measurement box will change from gray to blue. Refer to Figure OP-24.

8. To measure the other lens, select the L/R icon to switch to the other lens. Follow the above steps to measure the other contact lens. Refer to Figure OP-25.
9. When finished, print, transfer or clear the data by pressing the corresponding button.



Figure OP-22 Contact Lens Stand



Figure OP-23 Right Lens



Figure OP-24 Right Lens



Figure OP-25 Left Lens

# Operation (continued)

## Measurement Mode (continued)

### UV Measurement - LensChek Pro

The LensChek Pro can measure the percentage of UV light that passes through the lens. Set the “UV Measure” to “On” in the Setup Menu. When the lens value is stored, the percentage of UV light that passes through the lens is automatically displayed on the screen. Refer to Figure OP-26.

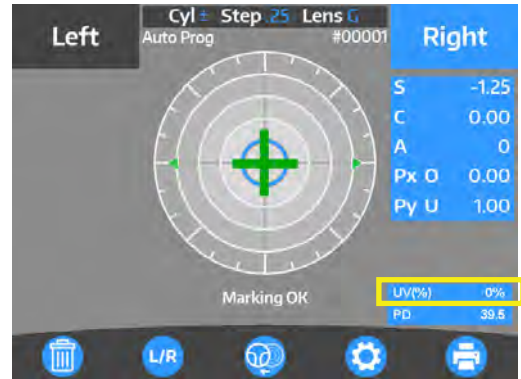

Figure OP-26 UV Measurement

### PD Measurement - LensChek Pro

The LensChek Pro can measure the PD distance for a pair of glasses.

1. Set the “PD Measure” to “On” in the Setup Menu.
2. Place the framed lens on the lens stand and lower the lens holder softly on the lens.
3. Pull out the lens table so that the bottom of the lens touches the lens table, and the corresponding Nose Pad is aligned in the center of the glasses. Refer to Figure OP-27.
4. When measuring the lens, the monocular PD measurement will automatically show up on the side of the lens that is being measured. Refer to Figure OP-28.
5. To measure the other lens, select the opposite lens by pressing the **L/R** button and follow the above procedure to measure the other lens.
6. When measuring the other lens, the monocular PD measurement will appear on the side of the lens being measured.
7. The binocular PD measurement will appear underneath the alignment target. Refer to Figure OP-29.



Figure OP-27 Orienting Glasses



Figure OP-28 PD Measurement



Figure OP-29 Total PD Measurement

# Operation (continued)

## Marking Lenses

1. Place your lens on the Lens Stand.

**Note:** For information on placing a lens on the LensChek Plus/Pro, refer to the [Lens Placement](#) section of this manual.

2. Position your lens using the Measurement Screen.
3. The lens is ready to be marked when the message “Marking OK” is displayed.
4. Press down the marking lever. Refer to Figure OP-30.
5. Lower the marking lever slowly until the tips of the marking pens touch the lens surface softly. Refer to Figures OP-31 and OP-32.
6. The marking lever returns to the initial position by releasing the finger slowly after marking on the lens.

**Note:** To prevent damage to the Marking Pens:

- Avoid touching the pen tips with your fingers.
- Do not lower the pens without first placing a lens on the Lens Stand.
- Mark your lenses gently.
- Do not mark a lens multiple times in the same location.

## Lenses With Astigmatism

For a lens with astigmatism, there are two methods for aligning the lens:

1. Move the lens until the axis value on the Measurement Screen equals the axis value in the patient prescription. Refer to Figure OP-33.  
or
2. Move the lens until the axis value on the Measurement Screen equals “0”. Refer to Figure OP-33.
3. When the lens is properly aligned, lower the Marking Lever by swinging the arm down, and gently pressing down on the marking lever until the marking pens make contact with the lens surface. Refer to Figures OP-30, OP-31, and OP-32.



Figure OP-30 Lens Ready for Marking



Figure OP-31 Swing Arm Down



Figure OP-32 Mark Lenses

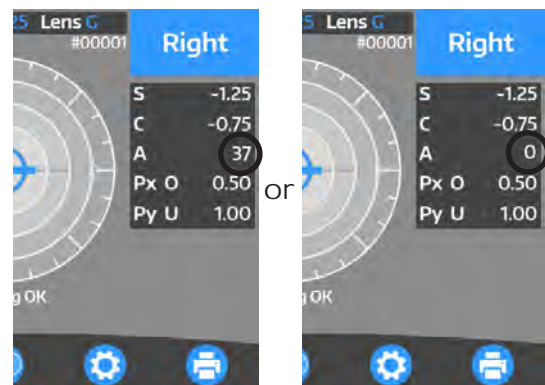

Figure OP-33 Align Axis for Marking

-continued-

# Operation (continued)

## Marking Lenses (continued)

### Prism Lenses

For prism lenses, the prescription is measured in either X-Y, P-B, or in mm.

### Prism Lenses Measured in X-Y

1. Select "X-Y" from "Prism" on the Setup screen.
2. Move the lens so that the prism values displayed on the screen match with the ones on the prescription. Refer to Figure OP-34.

The meanings of the prism values displayed are as shown below.

Px	I	Base In	(base inward)
Px	O	Base Out	(base outward)
Py	U	Base Up	(base upward)
Py	D	Base Down	(base downward)

### Prism Lenses Measured in P-B

1. Select "P-B" from "Prism" on the Setup screen.
2. Move the lens so that the prism values displayed on the screen match with the ones on the prescription. Refer to Figure OP-35.

P: Prism Value

B: Base Direction

### Lens Offset

1. Select "on" from "Prism (mm)" on the Setup screen to have the offset from optical center appear when measuring a lens.
2. Move the lens so that the offset value on the screen reads 0.0 for both values.

**Note:** The arrows shown indicate the direction from optical center. Refer to Figure OP-36.

**Note:** If "Prism" is set to "off", and "Prism (mm)" is set to "on", the offset from optical center will still be shown on the screen. "Prism" does not have to be set to either "A-B" or "X-Y" in order to have the offset shown.



Figure OP-34 X and Y Values Match

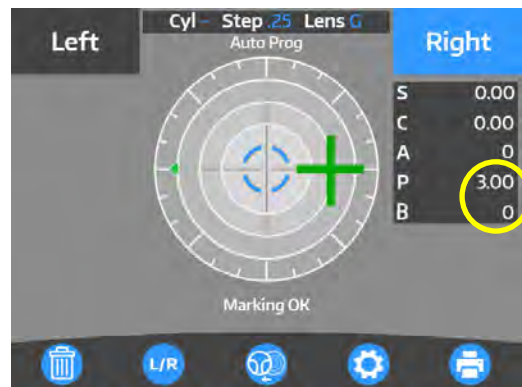

Figure OP-35 P and B Values Match



Figure OP-36 Offset Value

# Operation (continued)

## Printing Patient Data

The LensChek Plus/Pro allows you to print out your patient data by pressing the PRINT button.

Add measurement values are displayed only at the time of measurements of multifocal lens and progressive lens (Left: ADD1, Right: ADD2)

The unit of the prism value is different according to the setting.

Printout sample when unprocessed lens is measured

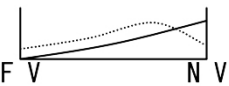
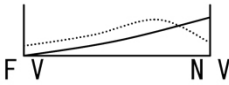
2013	12	13	15:40
NAME			
<R>			
S: +1.75			
C: -0.75			
A: 90			
ADD: +0.75		+1.00	
P: 0		0.00	
		D 1.25	
			
<L>			
S: +2.00			
C: -0.50			
A: 90			
ADD: +1.00		+1.25	
P: 0		0.00	
		D 1.25	
			

Practice name, comment etc. (printed out only when ID is set)  
Maximum number of characters: 44 characters (22 characters X 2 lines)

Measurement value of right lens

When the ADD value and assessment graph is printed (when "Graph Print" is set as "On" at the time of progressive lens measurement)

Measurement value of left lens

Printout sample in case of measurement error

Other errors displayed

- SPH Over
- CYL Over
- Prism Over
- Center Error

2013	12	13	15:40
NAME			
<R>			
S: +1.75			
C: -0.75			
A: 90			
ADD: +0.75		+1.00	
P: 0		0.00	
		D 1.25	
<L>			
Measurement Error			

# Cleaning & Maintenance

Due to its advanced design, the LensChek Plus/Pro requires very little routine maintenance. If you have any maintenance questions, contact your local dealer or the Reichert Customer Service Department as indicated in the [Introduction](#) section of this manual.

**CAUTION:** ANY REPAIR OR SERVICE TO THE LENSCHek PLUS/PRO MUST BE PERFORMED BY EXPERIENCED PERSONNEL OR DEALERS WHO ARE TRAINED BY REICHERT SO THAT CORRECT OPERATION OF THE LENSCHek PLUS/PRO IS MAINTAINED.

## Cleaning

**CAUTION:** DO NOT USE SOLVENTS OR STRONG CLEANING SOLUTIONS ON ANY PART OF THIS INSTRUMENT OR DAMAGE TO THE UNIT MAY OCCUR.

**CAUTION:** USE OF AMMONIABASED CLEANERS ON THE LIQUID CRYSTAL DISPLAY (LCD) OR ANY PLASTIC SURFACE MAY CAUSE DAMAGE TO THE INSTRUMENT.

### Main Unit

When the Main Unit, LCD Cover, and Operation Panel are dirty, wipe them with a clean, dry cloth. If there are stains that are hard to remove, moisten the soft cloth with a mild soap solution (1 cc of liquid dish soap to one liter of clean, filtered water (filtered below 5 microns)).

**CAUTION:** DO NOT USE ALCOHOL OR ANY SOLVENTS ON ANY EXTERNAL SURFACE OF THE INSTRUMENT OR DAMAGE TO THE PAINTED OR COATED SURFACE MAY OCCUR.

### Nosepiece Lens

Clean only the parts called out in Figure MM-01. Using canned air, blow dust and particles off of the Lens. If it is still dirty, wipe it lightly with a soft, dry cloth.

**CAUTION:** CLEAN CAREFULLY TO AVOID DAMAGING THE SURFACE OF THE OPTICAL PARTS. WHEN THE SURFACE IS DAMAGED, MEASUREMENTS MAY NOT BE CARRIED OUT ACCURATELY.

## Printer Paper Replacement

1. Press the Door Release button to open the Printer door. Refer to Figure MM-02.
2. Unroll a small amount of paper and install a new roll in the printer compartment so that the paper rolls out from the top. Refer to Figure MM-03.
3. Close the Printer Door and tear off the excess paper.

**Note:** Use Replacement Printer Paper (Pack of 5) - (P/N 12441)

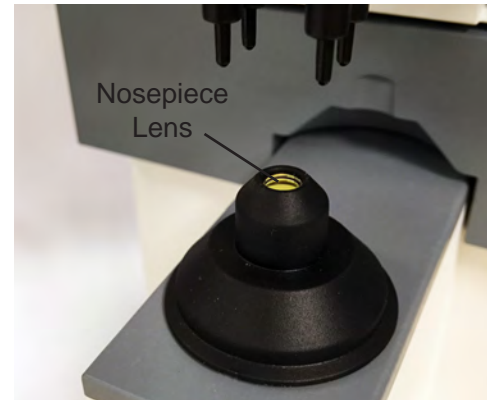

Figure MM-01 Nosepiece Lens



Figure MM-02 Door Release Button



Figure MM-03 Printer Paper Installation



# Cleaning & Maintenance (continued)

## Fuse Replacement

**CAUTION:** DISCONNECT POWER BEFORE ATTEMPTING TO REMOVE THE FUSES OR SERIOUS INJURY OR DEATH MAY OCCUR.

Replace the fuses in the Power Input Module with the fuses indicated in the Specifications section of this manual.

1. Remove input power to the instrument.
2. Remove the Fuse Holder by pressing in on the side tabs, and pull out the Fuse Holder from the Power Input Module. Refer to Figure MM-04.
3. Install new fuses (P/N RFAG20039) into the Fuse Holder. Refer to Figure MM-05.

**Note:** When ordering replacement fuses from Reichert, use only the part number listed above.

**Note:** Any fuse meeting the specifications listed in the Specifications section of this manual may be used in the device.

4. Push the Fuse Holder into the Power Input Module.

## Storage

There is a storage compartment located at the top of the instrument behind the LCD Screen. Lift the door to access the storage compartment. Refer to Figure MM-06.

## Power Cord Replacement

Replace the power cord with the following P/N's. When ordering a replacement power cord, use only the part numbers listed below.

- Power cord - 120 V (P/N WCBL10018)
- Power cord - 230 V (P/N WCBL10027)



**Figure MM-04 Fuse Holder**



**Figure MM-05 Replace Fuses**



**Figure MM-06 Storage Compartment**

# Cleaning & Maintenance (continued)

## Marking Pen Replacement

When the Marking Pens require replacement, follow the procedure below. Replacement Pens can be ordered in a set of 3 (P/N 15180-005).

1. Hold the Marking Lever down so that you can access the Marking Pens.
2. Push the Marking Pen up, so that the wide plastic Tabs are above the top of the Pen Holder. Refer to Figure MM-07.
3. Rotate the pen so that the wide Tabs are aligned with the opening at the top of the Pen Holder. Refer to Figure MM-08.
4. The Marking Pen can be removed by pulling it through the bottom of the Pen Holder. Refer to Figure MM-09.
5. Install a new Marking Pen by inserting it up through the Pen Holder, and twisting it so that the side plastic Tabs are aligned to hold it in place. Refer to Figure MM-10 and MM-11.

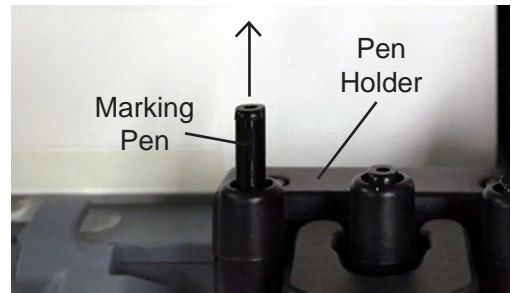

**Figure MM-07 Raise Pen**

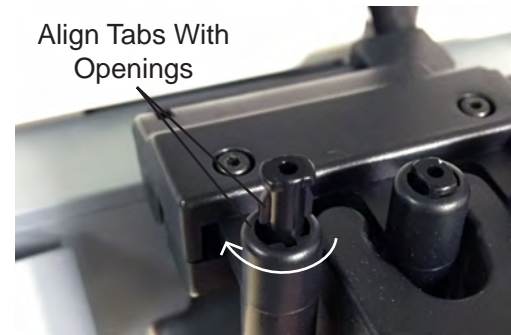

**Figure MM-08 Rotate Pen**

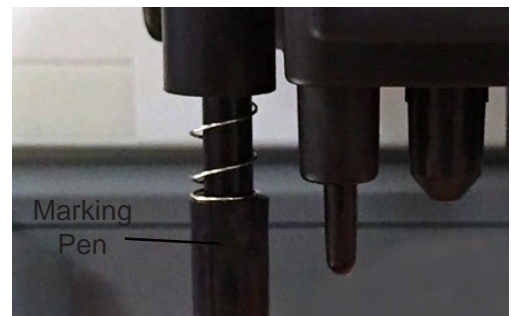

**Figure MM-09 Remove Pen**

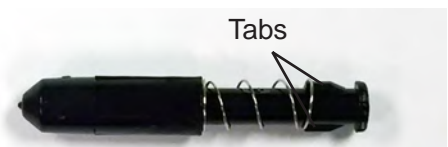

**Figure MM-10 Marking Pen**

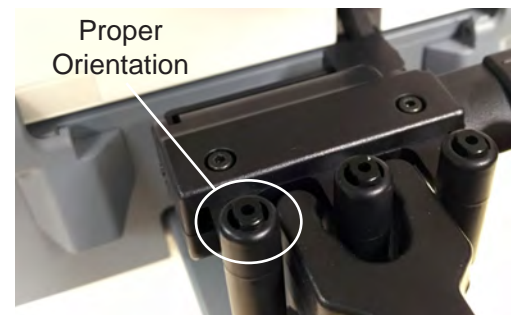

**Figure MM-11 Replaced Pen**

# Troubleshooting

## Troubleshooting Chart

The following charts detail common problems and solutions for the LensChek Plus/Pro.

ISSUE	SOLUTION
LensChek Plus/Pro has no power.	Turn on the Power switch. Press any button - LensChek Plus/Pro may be in sleep mode.
LCD Screen is blank.	Problem is damaged internal fuse or circuits. Replace fuses.
Inaccurate readings.	Clean the Nosepiece Lens.
Printer does not feed paper.	Check printer to verify it contains paper. Enable printer in the Data Output category on the Setup Screen.
Data does not print on the paper.	Check paper; it may be installed in printer upside down. Check printer to verify it contains thermal paper.
Pens do not mark lenses.	Replace the Marking Pens. <b>Note:</b> For instructions, refer to <u>Maintenance</u> section of the manual.
Buttons do not respond.	Press the buttons more slowly.
Initial Error	Any of the measurement values is more than “±0.25”. A lens is on the lens stand during startup. Remove the lens and restart the unit. Abnormal measurement because of dust or unnecessary light. Clean the lens stand.

ERROR	SOLUTION
Paper Empty	Replace the Printer Paper.
Printer Cover Open	Close the Printer Cover.
Printer Overheated	Printer is overheating. Allow printer time to cool off.
EEPROM Failure	Abnormality of memory. Contact Reichert.
Sensor Error	Abnormality of CMOS sensor. Contact Reichert.
Errors # 100-163 Displays with a three-digit number	Abnormality of electronic parts on the Control circuit board. Contact Reichert.
SPH Over	SPH measurement value is more than the upper limit of the measurement range.
CYL Over	CYL measurement value is more than the upper limit of the measurement range.
Prism Over	The prism measurement value is more than the upper limit of the measurement range.
ADD Over	ADD measurement value is more than the upper limit of the measurement range.
Measurement Error	Light path is obstructed due to dust or a scratch on the lens. (The measurement light does not enter into the light receiving sensor normally.) Clean the lens. Excess ambient light is interfering with the light path. Lower the lights. Measurement light LED does not turn on. Contact Reichert.
Center Error	Excess ambient light is interfering with the light path. Lower the lights.

**Note:** If problems still persist, contact Reichert as indicated in the Introduction section of this manual.

# Specifications

**Catalog Numbers:** LensChek Plus **15180**, LensChek Pro **15185**

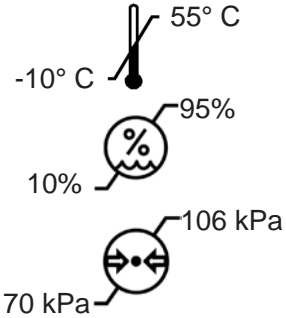
<b>Physical Dimensions</b>	
Size:	Weight, unpacked: 10.35 lbs. (4.7 Kg)
Height -	Color LCD Monitor: 4.75 x 3.5 in. (12.1 x 8.9 cm)
Display Up:	18.4 in. (46.7 cm)
Display Down:	16.5 in. (41.9 cm)
Width:	7.3 in. (18.4 cm)
Depth:	9.0 in. (22.9 cm)
<b>Electrical</b>	
Voltage: 100 - 240 volts AC 50/60 Hz	Bluetooth Power Source: 5V DC $\pm 5\%$ @ 200mA (typical)
Input Power: 60 VA	
Fuses: Time-Lag (T 2 A L 250V), 5x20mm, RoHS	
<b>Measurement Range</b>	
Sphere	-25D to +25.00D (0.01D, 0.12D, 0.25D steps)
Cylinder	0D to $\pm 10.00D$ (0.01D, 0.12D, 0.25D steps)
Axis	$1^\circ$ thru $180^\circ$ ( $1^\circ$ steps)
Addition	0D to $\pm 10.00D$ (0.01D, 0.12D, 0.25D steps)
Prism	0 to $10\Delta$ (0.01D, 0.12D, 0.25D steps)
UV Transmittance Measurement*	0 to 100% (1% steps)
Pupillary Distance Measurement*	45mm to 85mm (0.5mm steps)
Lens Power Measuring Wavelength	525 nm
UV Transmittance Measuring Wavelength*	375 nm
<b>Measurable Lens</b>	
Unprocessed Lens (diameter: 100mm) and Framed Lens	Single Lens, multifocal lens, progressive lens
Single Focus Hard and Soft Contact Lens	Use included Contact Lens Stand.
<b>Measurement Accuracy</b>	
Sphere	0D to $\pm 10.00D = \pm 0.25D$ , else 0.50D
Cylinder	$\pm 0.25D$
<b>Operational Conditions</b>	
Environmental:	
The environmental conditions are as follows:	
Operating:	
Temperature: $10^\circ$ to $40^\circ$ C ( $50^\circ$ to $104^\circ$ F)	
Relative Air Humidity: 30% to 90% (typical)	
Atmospheric Pressure: 70 kPa (20.7 in. Hg) to 106 kPa (31.3 in. Hg)	
Transportation & Storage:	
Temperature: $-10^\circ$ to $55^\circ$ C ( $+14^\circ$ to $131^\circ$ F)	
Relative Air Humidity: 10% to 95% (non-condensing)	
Atmospheric Pressure: 70 kPa (20.8 in. Hg) to 106 kPa (29.8 in. Hg)	
Exposure to extreme temperature conditions indicated above must not exceed 15 weeks.	

\* LensChek Pro only.

## **Specifications** (continued)

### **Disposal**

This product does not generate any environmentally hazardous residues. At the end of its product life, follow your local laws and ordinances regarding the proper disposal of this equipment.

### **Software Revision**

The software revision can be obtained by contacting Reichert Technologies.

The serial number identifies the manufacture date and will provide access to the software version.

# Guidance & Manufacturer's Declarations

<b>Table 201 – Guidance and Manufacturer’s Declaration</b> <b>Electromagnetic Emissions</b> <b>All Equipment and Systems</b>		
<b>Guidance and Manufacturer’s Declaration – Electromagnetic Emissions</b>		
The LensChek Plus/Pro is intended for use in the electromagnetic environment specified below. The customer or user of the LensChek Plus/Pro should ensure that it is used in such an environment.		
<b>Emissions Test</b>	<b>Compliance</b>	<b>Electromagnetic Environment</b> - Guidance -
RF Emissions CISPR 11	Group 1 Class B	The LensChek Plus/Pro uses RF energy only for its internal function. Therefore, its RF emissions are very low and are not likely to cause any interference in nearby electronic equipment.
Harmonics IEC 61000-3-2	Class A	The LensChek Plus/Pro is suitable for use in all establishments, including domestic establishments and those directly connected to the public low-voltage power supply network that supplies building for domestic power.
Flicker IEC 61000-3-3	Complies	

# Guidance & Manufacturer's Declarations (continued)

**Table 202 – Guidance and Manufacturer’s Declaration  
Electromagnetic Immunity  
All Equipment and Systems**

<b>Guidance and Manufacturer’s Declaration – Electromagnetic Immunity</b>			
The LensChek Plus/Pro is suitable for use in all establishments and is intended for use in the electromagnetic environment specified below. The customer or user of the LensChek Plus/Pro should ensure that it is used in such an environment.			
<b>Immunity Test</b>	<b>IEC 60601 Test Level</b>	<b>Compliance Level</b>	<b>Electromagnetic Environment - Guidance</b>
ESD IEC 61000-4-2	±8kV Contact ±2kV, ±4kV, ±8kV, ±15kV Air	±8kV Contact ±2kV, ±4kV, ±8kV, ±15kV Air	Floors should be wood, concrete or ceramic tile. If floors are synthetic, the r/h should be at least 30%.
EFT IEC 61000-4-4	±2kV Mains ±1kV I/Os	±2kV Mains ±1kV I/Os	Mains power quality should be that of a typical residential, commercial or hospital environment.
Surge IEC 61000-4-5	±0.51kV, ±11kV Differential ±0.51kV, ±1kV, ±2kV Common	±0.51kV, ±1kV Differential ±0.51kV, ±1kV, ±2kV Common	Mains power quality should be that of a typical residential, commercial or hospital environment.
Voltage Dips/Dropout IEC 61000-4-11	>95% Dip for 0.5 Cycle  60% Dip for 10 Cycles  30% Dip for 25 Cycles  >95% Dip for 5 Seconds  100% Dip for 0.5 Cycle at 0°, 45°, 90°, 135°, 180°, 225°, 270°, and 315°  100% Dip for 1 Cycle at 0° and 180°	>95% Dip for 0.5 Cycle  60% Dip for 10 Cycles  30% Dip for 25 Cycles  >95% Dip for 5 Seconds  100% Dip for 0.5 Cycle at 0°, 45°, 90°, 135°, 180°, 225°, 270°, and 315°  100% Dip for 1 Cycle at 0° and 180°	Mains power quality should be that of a typical residential, commercial or hospital environment. If the user of the LensChek Plus/Pro requires continued operation during power mains interruptions, it is recommended that the LensChek Plus/Pro be powered from an uninterruptible power supply or battery.
Power Frequency 50/60Hz Magnetic Field IEC 61000-4-8	30 A/m	30 A/m	Power frequency magnetic fields should be that of a typical residential, commercial or hospital environment.

# Guidance & Manufacturer's Declarations (continued)

<b>Table 204 – Guidance and Manufacturer’s Declaration</b> <b>Electromagnetic Immunity</b> <b>Equipment and Systems that are NOT Life-supporting</b>			
<b>Guidance and Manufacturer’s Declaration – Electromagnetic Immunity</b>			
The LensChek Plus/Pro is intended for use in the electromagnetic environment specified below. The customer or user of the LensChek Plus/Pro should ensure that it is used in such an environment.			
<b>Immunity Test</b>	<b>IEC 60601 Test Level</b>	<b>Compliance Level</b>	<b>Electromagnetic Environment - Guidance</b>
Conducted RF IEC 61000-4-6	3 Vrms 150 kHz to 80 MHz  6 Vrms 150 kHz to 80 MHz in ISM and amateur radio bands	(V1) = 3 Vrms  (V1) = 6 Vrms in ISM and amateur radio bands	Portable and mobile RF communications equipment should be no closer to any part of the LensChek Plus/Pro, including cables, than the recommended separation distance calculated from the equation applicable to the frequency of the transmitter.  Recommended Separation Distance:  $d=(3.5/V1)(\text{Sqrt } P)$  $d=(3.5/E1)(\text{Sqrt } P)$ 80 to 800 MHz  $d=(7/E1)(\text{Sqrt } P)$ 800 MHz to 2.7 GHz  Where P is the max output power rating of the transmitter in watts (W) according to the transmitter manufacturer and d is the recommended separation distance in meters (m).  Field strengths from fixed transmitters, as determined by an electromagnetic site survey, should be less than the compliance levels in each frequency range.  Interference may occur in the vicinity of equipment marked with the following symbol.  
Radiated RF IEC 61000-4-3	80 MHz to 2.5 GHz @ 3V/m  80 MHz to 2.7 GHz @ 10V/m	(E1) = 3 V/m  (E1) = 10 V/m	(This cell contains the same guidance text as the row above, including the RF symbol.)
Note 1: At 80 MHz and 800 MHz, the higher frequency range applies.			
Note 2: These guidelines may not apply in all situations. Electromagnetic propagation is affected by absorption and reflection from structures, objects and people.			
* Field strengths from fixed transmitters, such as base stations for radio (cellular/cordless) telephones and land mobile radios, amateur radio, AM and FM radio broadcast and TV broadcast cannot be predicted theoretically with accuracy. To assess the electromagnetic environment due to fixed RF transmitters, an electromagnetic site survey should be considered. The measured field strength in the location in which the ME Equipment or ME System should be observed to verify normal operation. If abnormal performance is observed, additional measures may be necessary, such as re-orienting or relocating the ME Equipment or ME System.			
* Over the frequency range 150 kHz to 80 MHz, field strengths should be less than [V1] V/m.			
* The ISM (industrial, scientific and medical) bands between 0,15 MHz and 80 MHz are 6,765 MHz to 6,795 MHz; 13,553 MHz to 13,567 MHz; 26,957 MHz to 27,283 MHz; and 40,66 MHz to 40,70 MHz. The amateur radio bands between 0,15 MHz and 80 MHz are 1,8 MHz to 2,0 MHz, 3,5 MHz to 4,0 MHz, 5,3 MHz to 5,4 MHz, 7 MHz to 7,3 MHz, 10,1 MHz to 10,15 MHz, 14 MHz to 14,2 MHz, 18,07 MHz to 18,17 MHz, 21,0 MHz to 21,4 MHz, 24,89 MHz to 24,99 MHz, 28,0 MHz to 29,7 MHz and 50,0 MHz to 54,0 MHz.			



# Guidance & Manufacturer's Declarations (continued)

<b>Table 206 – Recommended Separation Distances between Portable and Mobile RF Communications Equipment and the LensChek Plus/Pro for ME Equipment and ME Systems that are NOT Life-supporting.</b> <b>Guidance and Manufacturer’s Declaration - Electromagnetic Immunity</b>			
<b>Recommended Separation Distances for between Portable and Mobile RF Communications Equipment and the LensChek Plus/Pro</b>			
The LensChek Plus/Pro is intended for use in the electromagnetic environment in which radiated RF disturbances are controlled. The customer or user of the LensChek Plus/Pro can help prevent electromagnetic interference by maintaining a minimum distance between portable and mobile RF Communications Equipment and the LensChek Plus/Pro as recommended below, according to the maximum output power of the communications equipment.			
<b>Max Output Power of Transmitter (W)</b>	<b>Separation (m) 150kHz to 80 MHz</b> $d=(3.5/\sqrt{1})(\text{Sqrt } P)$	<b>Separation (m) 80 to 800 MHz</b> $d=(3.5/\sqrt{E1})(\text{Sqrt } P)$	<b>Separation (m) 800MHz to 2.5GHz</b> $d=(7/\sqrt{E1})(\text{Sqrt } P)$
0.01	0.1166	0.1166	0.2333
0.1	0.3689	0.3689	0.7378
1	1.1666	1.1666	2.3333
10	3.6893	3.6893	7.3786
100	11.6666	11.6666	23.3333
For transmitters rated at a maximum output power not listed above, the recommended separation distance (d) in meters (m) can be estimated using the equation applicable to the frequency of the transmitter, where P is the maximum output power rating of the transmitter in watts (w) according to the transmitter manufacturer. Note 1: At 80 MHz and 800 MHz, the separation distance for the higher frequency range applies. Note 2: These guidelines may not apply in all situations. Electromagnetic propagation is affected by absorption and reflection from structures, objects, and people.			

# Appendix

## RS232C Connection

Connections from the LensChek Plus/Pro to a computer are possible using the following settings:

- Baud Rate: 38400, 9600, or 115200 bps (bits per second)
- Character (word): 8 bit
- Parity: None
- Stop Bits: 1

Use a shield wire for a connecting cable to protect the output data from noise. When the measurement is output using RS232C, use a straight cable (D-sub 9 pins: male / D-sub 9 pins: female) for connection. The connections from the LensChek Plus/Pro to the computer are shown in the following diagram :

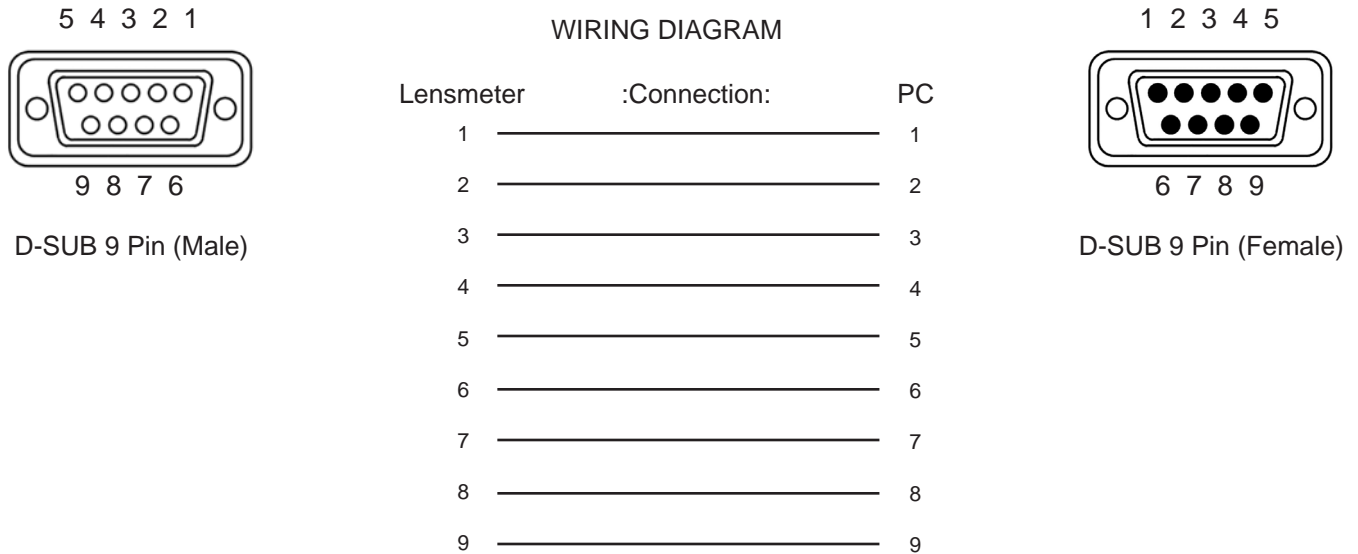

# Warranty

This product is warranted by Reichert Technologies (herein after referred to as Reichert) against defective material and workmanship under normal use for a period of one year from the date of invoice to the original purchaser. (An authorized dealer shall not be considered an original purchaser.) Under this warranty, Reichert's sole obligation is to repair or replace the defective part or product at Reichert's discretion.

This warranty applies to new products and does not apply to a product that has been tampered with, altered in any way, misused, damaged by accident or negligence, or which has had the serial number removed, altered or effaced. Nor shall this warranty be extended to a product installed or operated in a manner not in accordance with the applicable Reichert instruction manual, nor to a product which has been sold, serviced, installed or repaired other than by a Reichert factory, Technical Service Center, or authorized Reichert Dealer.

Lamps, bulbs, charts, cards and other expendable items are not covered by this warranty.

All claims under this warranty must be in writing and directed to the Reichert factory, Technical Service Center, or authorized instrument dealer making the original sale and must be accompanied by a copy of the purchaser's invoice.

This warranty is in lieu of all other warranties implied or expressed. All implied warranties of merchantability or fitness for a particular use are hereby disclaimed. No representative or other person is authorized to make any other obligations for Reichert. Reichert shall not be liable for any special, incidental, or consequent damages for any negligence, breach of warranty, strict liability or any other damages resulting from or relating to design, manufacture, sale, use or handling of the product.

## Patent Warranty

If notified promptly, in writing, of any action brought against the purchaser based on a claim that the instrument infringes a U.S. Patent, Reichert will defend such action at its expense and will pay costs and damages awarded in any such action, provided that Reichert shall have sole control of the defense of any such action with information and assistance (at Reichert's expense) for such defense, and of all negotiation for the settlement and compromise thereof.

## Product Changes

Reichert reserves the right to make changes in design or to make additions to or improvements in its products without obligation to add such to products previously manufactured.

## Claims for Shortages

We use extreme care in selection, checking, rechecking and packing to eliminate the possibility of error. If any shipping errors are discovered:

1. Carefully go through the packing materials to be sure nothing was inadvertently overlooked when the unit was unpacked.
2. Call the dealer you purchased the product from and report the shortage. The materials are packed at the factory and none should be missing if the box has never been opened.
3. Claims must be filed within 30 days of purchase.

## Claims for Damages in Transit

Our shipping responsibility ceases with the safe delivery in good condition to the transportation company. Claims for loss or damage in transit should be made promptly and directly to the transportation company.

If, upon delivery, the outside of the packing case shows evidence of rough handling or damage, the transportation company's agent should be requested to make a "Received in Bad Order" notation on the delivery receipt. If within 48 hours of delivery, concealed damage is noted upon unpacking the shipment and no exterior evidence of rough handling is apparent, the transportation company should be requested to make out a "Bad Order" report. This procedure is necessary in order for the dealer to maintain the right of recovery from the carrier.



## MERCOFRAMES OPTICAL CORP

5555 Nw 74 Ave. Miami, Fl 33166      305-882-0120  
[www.mercoframes.com](http://www.mercoframes.com)      [sales@mercoframes.net](mailto:sales@mercoframes.net)



15180-101 Rev. C

2016-11-04

