

REICHERT® PHOROPTOR®

Refracting Instrument

User's Guide



©2012 AMETEK, Inc.

AMETEK is a registered trademark of AMETEK, Inc.

Reichert, Reichert Technologies, and Phoroceptor are registered trademarks of Reichert, Inc.

All other trademarks are property of their respective owners.

The information contained in this document was accurate at time of publication. Specifications subject to change without notice. Reichert Technologies reserves the right to make changes in the product described in this manual without notice and without incorporating those changes in any products already sold.

ISO 9001/13485 Certified – Reichert products are designed and manufactured under quality processes meeting ISO 9001/13485 requirements.

No part of this publication may be reproduced, stored in a retrieval system, or transmitted in any form or by any means, electronic, mechanical, recording, or otherwise, without the prior written permission of Reichert Technologies.

Caution: Federal law restricts this device to sale by or on the order of a licensed physician. Rx only.

Table of Contents

Warnings and Cautions	4
Symbol Information	6
Introduction.....	7
Indications for Use	7
Contraindications	7
Instrument Setup	8
Unpacking Instructions.....	8
Accessories.....	8
Parts Identification.....	9
Illuminated Phoropter (Catalog # 11636, 11367, 11656, 11657).....	11
Setup.....	12
Attaching the Phoropter to the Stand	12
Connecting the Power (For Illuminated Phoropters Only).....	12
Attaching the Face Shields.....	13
Mounting Rotochart	13
Attaching Reading Rod.....	14
Leveling Phoropter	14
Adjust Rotation Lock.....	14
Description of Operation.....	15
Operating Principle.....	15
Instructions for Use	16
Suggested Preparation for Refraction.....	16
Optical Corneal Aligning Device.....	17
Taking Measurements	20
Distance Tests	20
Near Tests	21
Operation of the Sphere Lens Dials.....	22
Cylinder Power and Axis	24
Auxiliary Lens Dial	25
Rotary Prisms	26
Cross Cylinders	27
Jackson Cross Cylinder Tests	28
Procedure	28
Axis Check.....	28
Power Check	29
Cleaning & Maintenance	31
Cleaning.....	31
Sanitary Face Shields.....	31
Cleaning the Lenses.....	31
Cleaning Procedure.....	32
Lens Replacement	33
Replacing Lenses in Auxiliary Dial - Old Style Phoropters	33
Replacing Lenses in Auxiliary Dial - New Style Phoropters.....	33
Changing Cross Cylinder Lens Assembly	34
Adjustments	35
Adjusting Tension of Hinged Reading Rod Holder	35
Adjustment of Dial Rotation Tension.....	35
Troubleshooting.....	36
Specifications	37
Storage Conditions	38
Disposal	38
Warranty.....	39

Warnings and Cautions

Reichert, Inc. (Reichert) is not responsible for the safety and reliability of this instrument when:

- Assembly, disassembly, repair, or modification is made by unauthorized dealers or persons.
- Instrument is not used in accordance with this Service Manual.

WARNING: AN INSTRUCTION THAT DRAWS ATTENTION TO RISK OF INJURY OR DEATH.



WARNING: UNITED STATES FEDERAL LAW AND EUROPEAN REGULATIONS REQUIRE THAT THIS DEVICE BE PURCHASED ONLY BY A PHYSICIAN OR A PERSON ACTING ON BEHALF OF A PHYSICIAN.

WARNING: THIS INSTRUMENT SHOULD BE USED IN STRICT ACCORDANCE WITH THE INSTRUCTIONS OUTLINED IN THIS USER'S GUIDE. THE SAFETY OF THE PATIENT AND THE PERFORMANCE OF THE INSTRUMENT CANNOT BE GUARANTEED IF USED IN A MANNER NOT SPECIFIED BY REICHERT TECHNOLOGIES.

WARNING: DO NOT REPAIR OR SERVICE THIS INSTRUMENT WITHOUT AUTHORIZATION FROM THE MANUFACTURER. ANY REPAIR OR SERVICE TO THIS INSTRUMENT MUST BE PERFORMED BY EXPERIENCED PERSONNEL OR DEALERS WHO ARE TRAINED BY REICHERT SO THAT CORRECT OPERATION OF THIS INSTRUMENT IS MAINTAINED.

WARNING: MODIFICATIONS TO THIS INSTRUMENT IS NOT ALLOWED. ANY MODIFICATION TO THIS UNIT MUST BE AUTHORIZED BY REICHERT SO THAT CORRECT OPERATION IS MAINTAINED.

WARNING: IF THIS INSTRUMENT IS MODIFIED, APPROPRIATE INSPECTION AND TESTING MUST BE CONDUCTED TO ENSURE CONTINUED SAFE USE OF THIS INSTRUMENT.

WARNING: TO AVOID RISK OF ELECTRIC SHOCK, THIS EQUIPMENT MUST ONLY BE CONNECTED TO A SUPPLY MAINS WITH PROTECTIVE EARTH OR DAMAGE TO THE INSTRUMENT AND/OR INJURY TO THE OPERATOR OR PATIENT MAY OCCUR.

WARNING: ENSURE THAT THE VOLTAGE APPLIED TO THE UNIT IS THE SAME AS THE VOLTAGE THAT IS INDICATED ON THE DATA PLATE OR DAMAGE TO THE INSTRUMENT AND/OR INJURY TO THE OPERATOR OR PATIENT MAY OCCUR.

WARNING: THE INSTRUMENT MUST BE PLUGGED INTO AN OUTLET WITH AN EARTH GROUND. DO NOT REMOVE OR DEFEAT THE EARTH GROUND CONNECTION ON POWER INPUT CONNECTOR OR THE UNIT'S POWER CORD OF THIS INSTRUMENT OR DAMAGE TO IT AND/OR INJURY TO THE OPERATOR OR PATIENT MAY OCCUR.

WARNING: THIS INSTRUMENT IS NOT SUITABLE FOR USE IN THE PRESENCE OF FLAMMABLE ANESTHETIC MIXTURES, SUCH AS OXYGEN OR NITROUS OXIDE.

WARNING: DO NOT REMOVE THE OUTSIDE COVERS OF THE UNIT OR ATTEMPT TO REPAIR ANY INTERNAL PARTS. REPAIR AND SERVICE OF THE UNIT MUST BE PERFORMED BY EXPERIENCED REICHERT PERSONNEL OR AUTHORIZED DISTRIBUTORS WHO ARE TRAINED BY REICHERT.

WARNING: THE USE OF ACCESSORIES OR CABLES OTHER THAN THOSE SPECIFIED, WITH THE EXCEPTION OF THOSE SOLD BY THE MANUFACTURER AS REPLACEMENT PARTS FOR THE INTERNAL COMPONENTS, MAY RESULT IN INCREASED EMISSIONS OR DECREASED IMMUNITY OF THE EQUIPMENT OR SYSTEM.

WARNING: PRIOR TO INSTALLING THE AUTO PHOROPTOR ONTO THE STAND ARM, VERIFY THAT THE ROD ON THE STAND ARM IS SECURE BEFORE ATTEMPTING TO INSTALL THE AUTO PHOROPTOR OR DAMAGE TO THE UNIT AND/OR PATIENT MAY OCCUR.

WARNING: REMOVAL OF THE SAFETY SCREW MAY CAUSE THE INSTRUMENT TO DETACH FROM ITS SUPPORTING ARM AND CAUSE SERIOUS INJURY.

Warnings and Cautions (continued)

CAUTION: AN INSTRUCTION THAT DRAWS ATTENTION TO THE RISK OF DAMAGE TO THE PRODUCT.



CAUTION: THE INTERNAL CIRCUITRY OF THE INSTRUMENT CONTAINS ELECTROSTATIC DISCHARGE SENSITIVE DEVICES (ESDS) THAT MAY BE SENSITIVE TO STATIC CHARGES PRODUCED BY THE HUMAN BODY. DO NOT REMOVE THE COVERS WITHOUT TAKING PROPER ESDS PRECAUTIONS.

CAUTION: DO NOT USE SOLVENTS OR STRONG CLEANING SOLUTIONS ON ANY PART OF THIS INSTRUMENT OR DAMAGE TO THE UNIT MAY OCCUR.

CAUTION: DO NOT AUTOCLAVE OR DISINFECT THE UNIT OR ACCESSORIES USING HIGH TEMPERATURES EXCEEDING THE RECOMMENDED TEMPERATURES INDICATED IN THE SPECIFICATIONS SECTION OF THIS MANUAL OR DAMAGE TO THE UNIT OR ACCESSORIES MAY OCCUR.

CAUTION: AVOID TOUCHING THE OPTICAL COMPONENTS OF THE DEVICE TO PREVENT REDUCED PERFORMANCE BY LEAVING BEHIND FINGERPRINTS OR OILS ON THE LENSES.

CAUTION: DO NOT IMMERSE THE PHOROPTOR IN FLUIDS OR DAMAGE TO THE UNIT MAY OCCUR.

CAUTION: ENSURE THAT THE VOLTAGE APPLIED TO THE UNIT IS THE SAME AS THE VOLTAGE THAT IS INDICATED ON THE DATA PLATE OR DAMAGE TO THE UNIT MAY OCCUR.

Symbol Information

The following symbols appear on the instrument.



CAUTION - Consult accompanying documents.



Type B Product Classification



Conformity with mandatory European safety requirements



Date of Manufacture



Waste of Electrical and Electronic Equipment

REF

Catalog Number.

SN

Serial Number.



Accompanying Documents must be consulted



Fragile Contents in Shipping Container - handle with care.



Keep Dry - Package shall be kept away from rain.

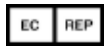

Authorized Representative in European Community.



This Way Up - Indicates the correct upright position of package.

Introduction

Congratulations on your purchase of the Reichert Technologies® (hereafter referred to as Reichert®) Phoroptor®.

This User's Guide is designed as a training and reference manual for operation, maintenance, and troubleshooting. We recommend that you read it carefully prior to use and follow the instructions in the guide to ensure optimum performance of your new instrument. Properly trained eyecare professionals such as ophthalmologists, optometrists, opticians and eye care technicians should operate this instrument. All parts of this ME system are suitable for use within the patient environment.

Please retain this guide for future reference and to share with other users. For additional copies of this manual or questions related to the Phoroptor, contact your local authorized Reichert dealer or contact our Customer Service department directly at:

Tel: 716-686-4500

Fax: 716-686-4555

E-mail: reichert.information@ametek.com

Indications for Use

The Reichert Phoroptor is designed for:

- Subjective refraction.
- Determination of correction data for refraction anomalies and binocular functions being the basis to manufacture tailored glasses and contact lenses.
- Use in refraction rooms in clinics, physicians' or opticians' practices.
- Operation by physicians or opticians or properly trained personnel.
- Installation under the conditions for medical equipment.

Note: Collision with other equipment has to be avoided.

Contraindications

None.

Instrument Setup

Unpacking Instructions

Great care has been taken to deliver your Phoroptor to you safely. Please read this User's Guide before operating the unit.

The instrument is packaged in a shipping container to protect the instrument from damage during shipment. Please remove the Phoroptor and the accompanying equipment from the packaging material in the following manner.

Note: Please retain the packaging so that if future transportation is required, the instrument can be sent in its original packaging.

1. Open the top of the outer box and remove the top box containing the Reading Rod. Refer to Figure IS-1.
2. Open the reading rod and remove the rod from the paper and the plastic it is wrapped in and set aside.
3. Remove the accessories and the accessories box from the sides of the container. Refer to Figure IS-2.
4. Pull the inner box containing the Phoroptor up and out of the outer box. Refer to Figure IS-2.
5. Open the Phoroptor box and remove the top foam. Refer to Figure IS-3.
6. Remove the phoroptor from the rest of the packaging and place it on a clean, soft surface. Refer to Figure IS-4.
7. Remove the plastic bag from the Phoroptor. Refer to Figure IS-4.
8. Place the packaging in a safe place so that if transportation is required in the future, it will be available.

Your new Phoroptor refracting instrument and accessories were carefully packed and checked prior to shipment; however, please check condition and contents upon delivery. In addition to your Phoroptor, this shipment should include the following accessories.

Accessories

- Cylinders in Cells in Accessory Case
 - Plus Phoroptors, +0.12D and +2.00D (P/N 11642)
 - Minus Phoroptors, -0.12D and -2.00D (P/N 11632)
- 3 pairs White Nylon Face Shields (P/N 11644-000)
- Near Point Rotochart with Instructions (P/N 11999)
- Reading Rod (P/N 11636-860)
- Reading Rod Card Holder (P/N 11628-911)
- Phoroptor Securing Screw (P/N 11330-317)
(Not for use with Reichert Advantage Stand.)
- Dust Cover (P/N 11625-282)
- Transformer, 5V DC (P/N 11636-401, for Illuminated Phoroptors only.)

Note: If any of the above accessories or parts are missing, immediately contact Reichert so that the missing accessories or parts can be shipped.

For more accessories or to order any of these accessories, contact your authorized Reichert dealer.



Figure IS-1 Outer Box



Figure IS-2 Inner Box

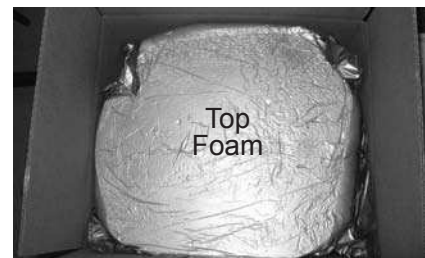

Figure IS-3 Top Foam

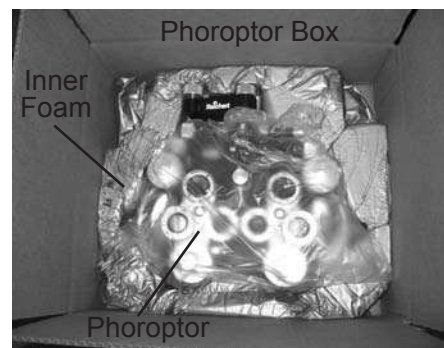
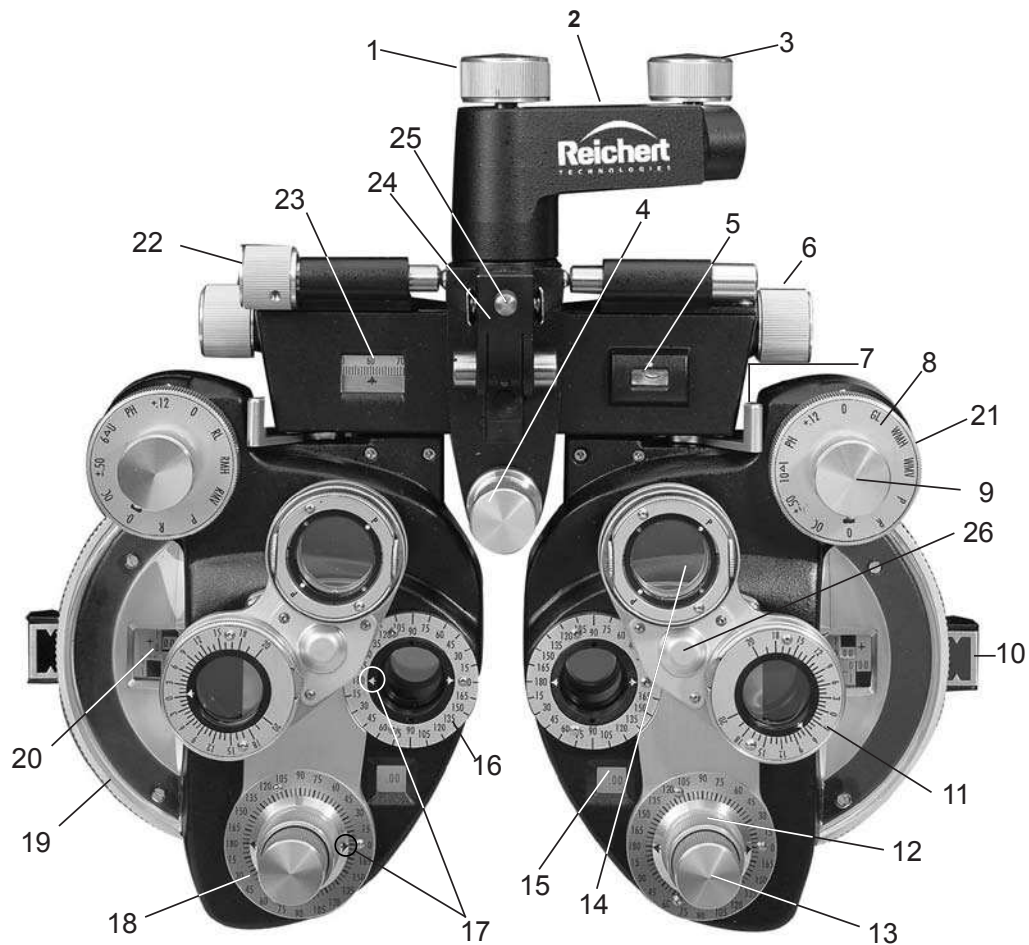

Figure IS-4 Inner Foam

Parts Identification



Phoroceptor (Front)

- | | |
|-----------------------------|-----------------------------------|
| 1. Rotation Adjustment Knob | 14. Cross Cylinder Unit |
| 2. Mounting Bracket | 15. Cylinder Power Scale |
| 3. Tilt Clamp Knob | 16. Cylinder Axis Reference Scale |
| 4. Forehead Rest Knob | 17. Cylinder Axis Indicators |
| 5. Spirit Level | 18. Cylinder Axis Scale |
| 6. P.D. Knob | 19. Weak Sphere Dial |
| 7. Vergence Lever | 20. Sphere Power Scale |
| 8. Auxiliary Lens Scale | 21. Strong Sphere Control |
| 9. Auxiliary Lens Knob | 22. Leveling Knob |
| 10. Corneal Aligning Device | 23. P.D. Scale |
| 11. Rotary Prism Unit | 24. Reading Rod Holder |
| 12. Cylinder Axis Knob | 25. Reading Rod Clamp Screw |
| 13. Cylinder Power Knob | 26. Turret Assembly |

Instrument Setup (continued)

Parts Identification (continued)

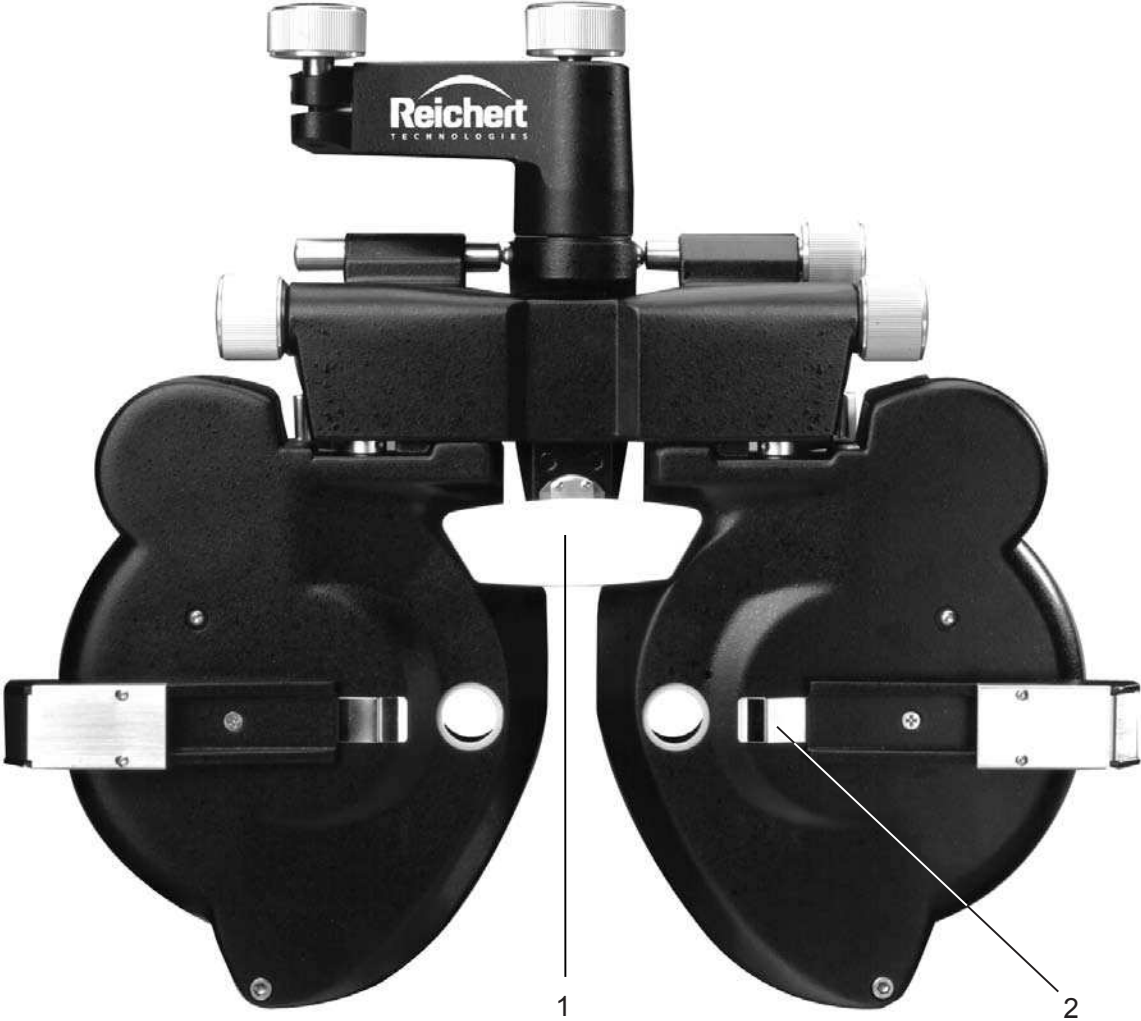

Phoropter (Back)

1. Forehead Rest

2. Spring Clip

Note: The configuration of the Reichert® Phoropter is a registered trademark in the United States & Canada.

Instrument Setup (continued)

Parts Identification (continued)

Illuminated Phoropter

The illumination option reduces eyestrain by lighting the most commonly used scales and dials. Lighting is provided by energy efficient, cool running LEDs (light emitting diodes) that require no maintenance. Operators simply plug the Illuminated Phoropter into the appropriate power receptacle to turn the lighting on. All other instrument functions remain unchanged.

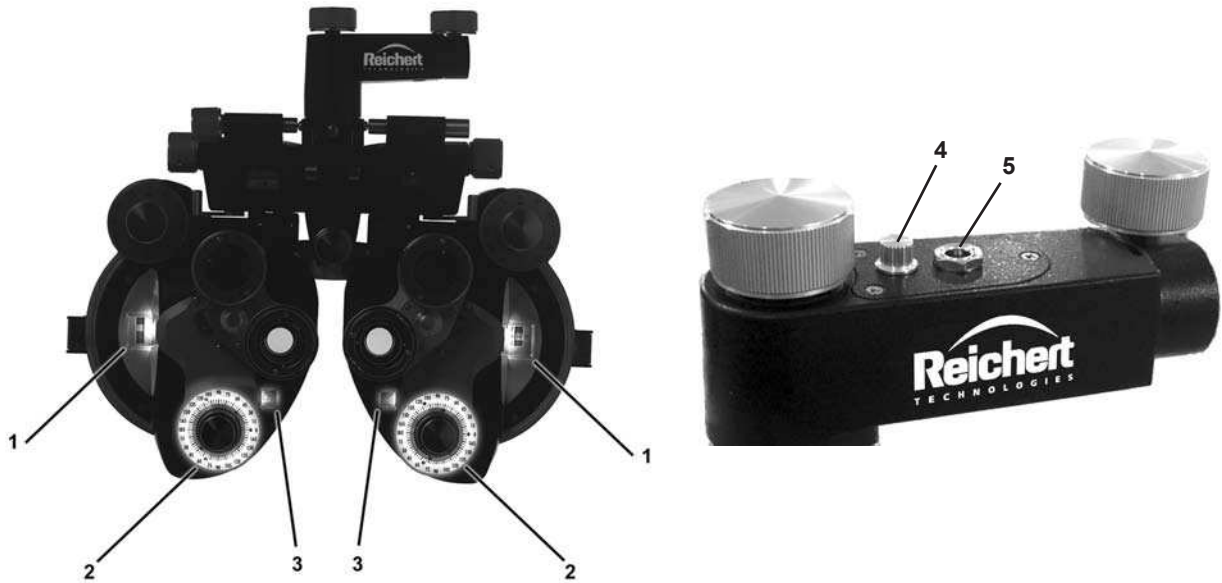

Illuminated Features

1. Sphere Scale
2. Cylinder Axis Scale
3. Cylinder Power Scale

4. Rheostat Control
5. Power Input

Setup

Attaching the Phoroceptor to the Stand

WARNING: PRIOR TO INSTALLING THE PHOROCEPTOR ONTO THE STAND ARM, VERIFY THAT THE ROD ON THE STAND ARM IS SECURE BEFORE ATTEMPTING TO INSTALL THE PHOROCEPTOR OR DAMAGE TO THE UNIT AND/OR PATIENT MAY OCCUR.

WARNING: REMOVAL OF THE SAFETY SCREW MAY CAUSE THE INSTRUMENT TO DETACH FROM ITS SUPPORTING ARM AND CAUSE SERIOUS INJURY.

1. Place the Phoroceptor on the instrument stand arm by sliding the Mounting Bracket over the end of the arm until the threaded hole of the stand arm lines up with the slotted hole in the bottom of the Mounting Bracket. Refer to Figure SU-1.
2. A Retaining Screw has been provided to prevent the Phoroceptor from falling off the stand. Insert the screw up through the slotted hole and thread it into the stand arm. Tighten the screw firmly in place. Refer to Figure SU-1.

Note: The Retaining Screw (P/N 11330-317) provided with the Phoroceptor will work with most stands. If using an Advantage Stand from Reichert, use Retaining Screw (P/N 15072-032) that comes with the stand on the Phoroceptor Arm.

Note: The instrument cannot slide off the arm at this point, but can be tilted forward or back.

3. Tighten the Tilt Clamp Knob and the Phoroceptor will be held firmly in the desired position. Refer to Figure SU-1.

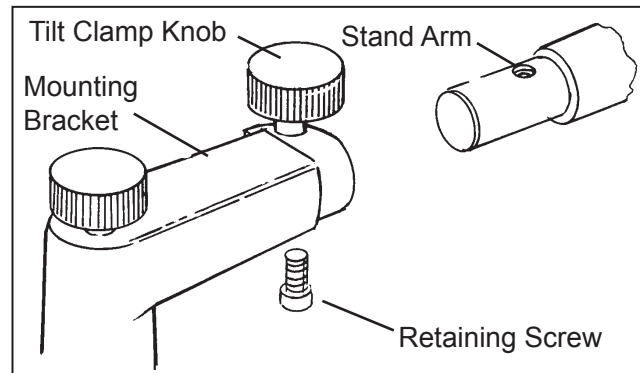

Figure SU-1 Attaching Phoroceptor to Stand

Connecting the Power (For Illuminated Phoroceptors Only)

1. Insert the male connector into the Power Input receptacle on the Phoroceptor Mounting Bracket.

WARNING: CARE MUST BE TAKEN TO ARRANGE THE CABLE FOR THE ADAPTOR SO THAT IT DOES NOT PRESENT A TRIPPING HAZARD TO THE EXAMINER OR A DANGER TO THE PATIENT.

WARNING: POSITION THIS INSTRUMENT SO THAT IT IS NOT DIFFICULT TO OPERATE THE DISCONNECTION DEVICE (PLUG).

2. Plug the adapter into an outlet with the correct input voltage.
3. Light should automatically turn on when plugged in.
4. To adjust the brightness of the lights, turn the Rheostat Control Knob. Refer to Page 10.
 - Counterclockwise rotation dims the LEDs.
 - Clockwise rotation brightens the LEDs.

Note: The Rheostat Control Knob does not go "OFF," it only dims and brightens the LED's. To shut the lights off entirely you must unplug the adaptor.

Instrument Setup (continued)

Setup (continued)

Attaching the Face Shields

1. Each Face Shield is held in place by a Spring Clip. Attach by sliding the edge of the Face Shield under the clip matching the position of the shield aperture to the main aperture of the Phoroceptor. Refer to Figure SU-2.

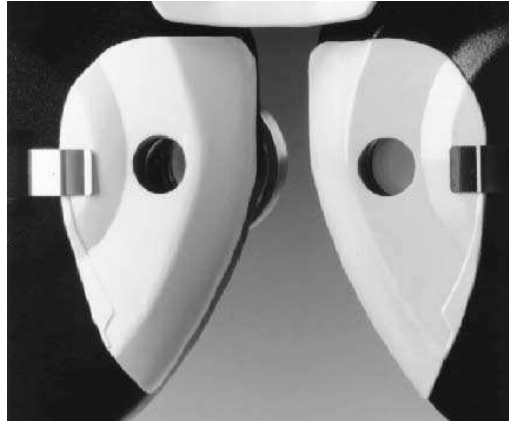

Figure SU-2 Face Shields

Mounting Rotochart

1. To attach the Rotochart, insert one pin into the hole; slide the edge under the clip; and insert the other pin into the second hole. Refer to Figure SU-3.

Note: The Card Holder on the Reading Rod is specially designed for the Near Point Rotochart™ but the spring clip will hold other cards.

Note: By means of its knurled ring, the Card Holder can be rotated to present the characters on either side of the Rotochart.



Figure SU-3 Mounting Rotochart

Instrument Setup (continued)

Setup (continued)

Attaching Reading Rod

1. Insert the Reading Rod into the hinged Reading Rod Holder and tighten the Reading Rod Clamp Screw.

Note: The rod supplied with the Phoroptor is 28 inches (71 cm) in length to allow testing for multi-focal lenses.

Note: The graduations are in inches, centimeters, and diopters.

Leveling Phoroptor

1. Move the Phoroptor into a working position.
2. Use the Leveling Adjustment Knob to adjust the horizontal position of the Phoroptor. Turn the Leveling Knob until the instrument is level as shown on the Spirit Level.

Adjust Rotation Lock

1. This is an adjustable friction lock. It is designed to hold the instrument in place but permits you to rotate the Phoroptor against a friction load. The knob allows friction adjustment to your preference.

Description of Operation

Operating Principle

All known refraction methods can be applied to the Phoroptor. The order of the examination steps are freely selectable by the end user.

The Phoroptor is made up of several sets of dials that control lenses inside the unit. Once the operator becomes familiar with the lenses and dials, operation of the Phoroptor will become quick and routine.

The main parts of the Phoroptor are as follows:

- The Auxiliary Lens Knob (top dial) controls the type of test being performed. This allows the operator to insert different type of test lenses, such as Maddox lenses, red/green lenses, or to open or occlude the apertures.

Note: The right side of the Phoroptor (the patient's left eye) has white Maddox lenses, and the green lens for the red/green test. The left side of the Phoroptor (the patient's right eye) has red Maddox lenses, and the red lens for the red/green test.

- The Strong Sphere Control (outer dial of the top knob) changes the sphere value in large steps, while the Weak Sphere Dial (large outer wheel on the sides of the Phoroptor) changes the sphere value in small steps.
- The Cylinder Power Knob (inner lower dial) changes the cylinder value, and the Cylinder Axis Knob (outer lower dial) changes the axis.

Note: When changing lens powers, numbers written in black are PLUS, while numbers written in red are MINUS.

- There is a Turret Assembly on each side of the Phoroptor which you can rotate in to enable the cross cylinder and prism lenses.

Instructions for Use

Suggested Preparation for Refraction

Techniques in preparing for refraction vary considerably. The points covered here are offered as suggestions which can be arranged and modified to comply with your own particular technique.

1. Room illumination should be adequate for the practitioner to see both patient and Phoroceptor. If room and instrument stand light are not sufficient, it may be necessary to use a light from a retinoscope, transilluminator, or pen pocket flashlight to see cornea and pupils in the center of the aperture.
2. To ensure that the patient's eyes are fixating properly, a distant target, such as a (muscle) light or single large letter, may be used.

Note: The importance of properly adjusting the Phoroceptor to the patient at the start of the examination cannot be overemphasized.

3. To avoid fatigue, make certain that the patient is seated in a comfortable position so that, without undue effort, he will keep his eyes centered with the apertures of the Refractor. The features of a modern chair contribute appreciably to the comfort of the patient.
4. If the chair has been lowered to its lowest position for seating of the patient, the chair should be raised until the patient's eyes are on a level with the practitioner's eyes in his normal working position.
5. The Phoroceptor should be moved close to the patient's face and positioned so that his eyes and the Phoroceptor apertures are on the same level. The top line of the test chart should be level with or slightly below the lens apertures.
6. With the above accomplished, lock arm motion.
7. Adjust Phoroceptor Forehead Rest so that the patient's corneas are approximately 13.75 mm as indicated on the Corneal Aligning Device.

Note: When it is known or suspected that the patient has a significant refractive error, use the Corneal Aligning Device rather than visually judging distance. For use of Corneal Aligning Device, refer to page 16.

8. When using the chair headrest, it should be brought forward until the pads rest against the patient's head. The patient should not be allowed to move his head backward to meet the headrest as this will invariably cause him to tilt his head.
9. After the headrest is locked into position, the interpupillary adjustment is made by turning either P.D. Adjustment Knob until the pupil of each eye is centered behind its respective aperture while the patient is looking straight ahead.
10. If the patient's head is held level in the headrest, and the Spirit Level shows the bubble in the center, both eyes should appear on the same horizontal level in the apertures. If one eye is higher than the other, it will be observed by noting the position of the pupils in the apertures.*

*When this occurs, the question of tilting the Phoroceptor arises. The patient may have inadvertently tilted his head or he may have an anatomical anomaly. Depending upon whether the patient's eyeglasses are to be adjusted to center the lenses before his eyes or decentered vertically to compensate for the vertical imbalance of the eyes, the Phoroceptor may or may not be tilted to center the patient's eyes in the apertures.

Instructions for Use (continued)

Optical Corneal Aligning Device

The Phoroceptor provides an optically additive lens system and an optical Corneal Aligning Device, both essential for a true additive effective power determination.

1. The additive lens system refers to the addition of lens powers within the Phoroceptor.
2. The effective power combination of two or more lenses cannot be obtained accurately by simple addition of their individual powers.
3. Allowances must be made which depend in an intricate way on the powers, the curves, the thicknesses, the index of glass, and the air space separating the lenses.
4. Accordingly, in the Phoroceptor, two essential features have been incorporated to ensure the accuracy of the lens prescription.
 - Specially computed lenses and lens separations such that their designated powers can simply be added together to give the effective power of any possible combination.
 - A means for placing this additive lens power system at a specified distance from the eye.
5. When either of these elements is neglected, the corrective accuracy of the lens system is impaired, particularly with regard to combinations of high power lenses.
6. The distance at which the spectacle lens is generally worn is considered to be 13.75 mm from the apex of the cornea to the ocular surface of the lens.
7. With this as the standard, the posterior lens surface of the Phoroceptor must be placed at a distance of 13.75 mm if the Phoroceptor reading is to be directly applied to spectacle lens power.
8. In the Phoroceptor, this condition is obtained when the zero setting of the sight in the Corneal Aligning Device is lined up with the apex of the cornea. Refer to Figure OC-1.
9. To establish proper distance between the patient's eyes and the instrument, adjust the position of the Forehead Rest using the knurled Forehead Rest Knob.

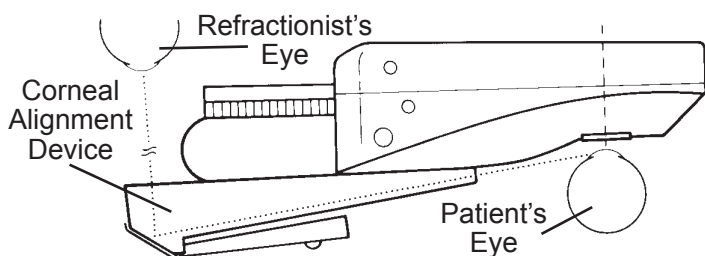

Figure OC-1 Corneal Alignment Device

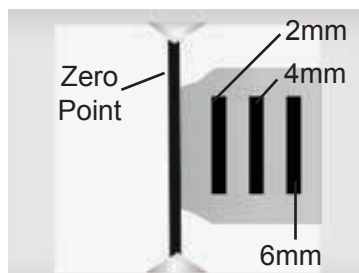

Figure OC-2 Corneal Alignment Device Close Up

Note: Make certain that the patient's forehead is resting firmly against the headrest.

10. This adjustment will move the patient's eyes nearer to or farther from the instrument.
11. From the front of the instrument, look into the Corneal Aligning Device. The upper and lower pointers should be in exact alignment with the solid black line visible on the mirror. This is the zero point indicating a 13.75 mm distance from the apex of the patient's cornea. Also visible are three hash marks, each representing 2 mm additive distance. Refer to Figure OC-2.
12. With the patient's forehead positioned against the headrest, adjust the headrest to position the apex of the cornea at the zero line (13.75 mm from the lenses).
13. If, with the headrest retracted, the apex of the cornea appears nasally from the zero line, simply add the distance to 13.75 mm. (This figure is the total distance from the cornea to the strong sphere, or the vertex distance.)

Instructions for Use (continued)

Optical Corneal Aligning Device (continued)

14. The scale reading of the Corneal Aligning Device is used with the Correction Factor Table to determine the correction factor for the power reading.

Note: The correction factor is always added to the Phoropter reading as a plus quantity.

Example:

- If the Phoropter reading is +8.00D and the Corneal Aligning Device scale indicates an additional 4 mm, the correction factor according to the table is +0.27. Therefore, the power of the correcting lens is obtained by adding +0.27 to +8.00 diopters, which equals +8.27 diopters, when the spectacle lens is worn at 13.75 mm from the cornea.
- If the Phoropter reading is -11.50D, and the Corneal Aligning Device indicates an additional 5 mm, it is necessary to interpolate to obtain the correction factor. Interpolating between -11.00 and -12.00, the correction factor according to the table is +0.62. Therefore, the power of the correction lens is obtained by adding +0.62 to -11.50, which equals -10.88 diopters, when the spectacle lens is worn at 13.75 mm.

15. The tables can also be applied in the case where the spectacle lenses are to be worn at one distance, the test is made at another distance, and neither distance is at 13.75 mm.

Note: First, assume the Corneal Aligning Device indicates an additional 4 mm; that the spectacle lenses are to be worn at 12 mm instead of 13.75 mm; and that the Phoropter reading is +13.00 diopters. In this case, fitting distance of 12 mm is subtracted from the refracting distance of 17.75 mm (13.75 mm plus 4 mm), the result being 5.75 mm. In the table for plus Phoropter readings at the horizontal row corresponding with +13.00 diopters, the value of 5.75 falls between the 5 mm and 6 mm columns. By interpolation, the addition is found to be 1.05D. Hence, the power of the spectacle lens should be +13.00 plus +1.05 for a total of +14.05 diopters.

Instructions for Use (continued)

Optical Corneal Aligning Device (continued)

CORRECTION FACTOR TABLE PLUS							CORRECTION FACTOR TABLE MINUS						
Power Reading	1mm	2mm	3mm	4mm	5mm	6mm	Power Reading	1mm	2mm	3mm	4mm	5mm	6mm
+1.00	.001	.002	.003	.004	.005	.006	- 1.00	.001	.002	.003	.004	.005	.006
+2.00	.004	.008	.01	.02	.02	.02	- 2.00	.01	.01	.02	.02	.02	.03
+3.00	.01	.02	.03	.04	.05	.06	- 3.00	.01	.02	.03	.04	.04	.05
+4.00	.02	.03	.05	.07	.08	.10	- 4.00	.02	.03	.05	.06	.08	.09
+5.00	.03	.05	.07	.11	.12	.15	- 5.00	.03	.05	.07	.10	.12	.15
+6.00	.04	.07	.10	.16	.18	.21	- 6.00	.04	.07	.10	.15	.17	.22
+7.00	.05	.10	.14	.21	.25	.29	- 7.00	.05	.10	.14	.20	.24	.30
+8.00	.06	.13	.19	.27	.33	.39	- 8.00	.06	.13	.19	.25	.31	.38
+9.00	.08	.16	.24	.34	.42	.51	- 9.00	.08	.16	.24	.31	.39	.47
+10.00	.10	.20	.30	.42	.52	.64	- 10.00	.10	.20	.30	.38	.48	.57
+11.00	.12	.25	.37	.51	.64	.78	- 11.00	.12	.24	.36	.46	.57	.68
+12.00	.15	.30	.45	.61	.77	.93	- 12.00	.14	.28	.42	.55	.67	.80
+13.00	.18	.35	.53	.72	.91	1.10	- 13.00	.16	.33	.48	.64	.78	.94
+14.00	.21	.41	.62	.84	1.06	1.29	- 14.00	.19	.38	.55	.74	.90	1.08
+15.00	.24	.47	.71	.97	1.22	1.49	- 15.00	.22	.43	.63	.85	1.03	1.23
+16.00	.27	.53	.81	1.11	1.39	1.71	- 16.00	.25	.49	.72	.96	1.17	1.39
+17.00	.30	.60	.92	1.26	1.58	1.94	- 17.00	.28	.55	.81	1.08	1.32	1.56
+18.00	.33	.67	1.03	1.41	1.78	2.19	- 18.00	.31	.62	.91	1.21	1.48	1.74
+19.00	.37	.75	1.15	1.57	1.99	2.47	- 19.00	.35	.69	1.02	1.34	1.65	1.93
+20.00	.41	.83	1.28	1.74	2.22	2.78	- 20.00	.39	.77	1.13	1.48	1.82	2.14

The above table is based on the Effective Power Formula; $P(e) = P/(1-(s*P))$

P = Phoropter Power reported (@ 13.75mm)

s = the distance moved from the spectacle vertex distance

P(e) = the corrected power required at the spectacle vertex distance

The correction factor is the difference between the effective power and the Phoropter power $cf = P(e)-P$.

Taking Measurements

Distance Tests

1. All tests for distance (static retinoscopy, subjective, phorometry) are generally made with the Vergence Levers in the extreme outward position. Refer to Figure TM-1.
2. At this setting the lens systems are parallel. (For shorter test distances than 20 feet, compensatory adjustments may be made by moving the levers inward).

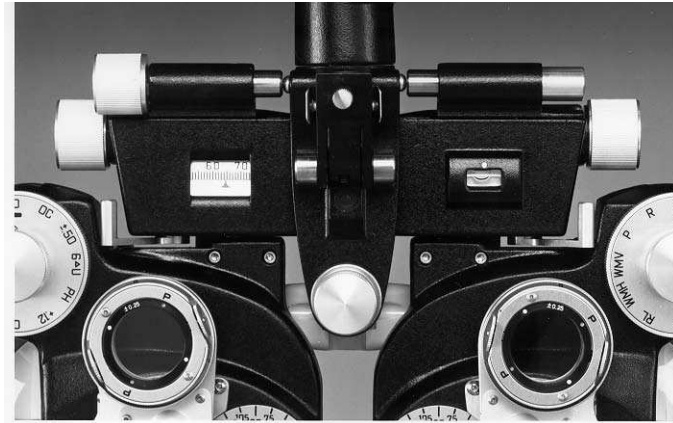

Figure TM-1 Vergence Levers Out (Distance Tests)

Instructions for Use (continued)

Taking Measurements (continued)

Near Tests

1. All tests for near (dynamic retinoscopy, amplitude of accommodation, dynamic cross cylinder, positive and negative relative accommodation, phorometry) are generally made with the Vergence Levers in the inward (converged) position. Refer to Figure TM-2.
2. With a distance PD of 64mm, moving both levers from the extreme outward position to the extreme inward position converges the instrument apertures for the near test at 16 inches. At the same time, aperture separation is decreased by 4mm.
3. For PD settings greater than 64mm, the instrument apertures are slightly under converged; reducing the PD adjustment by 1mm or less compensates for it.
4. For PD settings less than 64mm, the instrument apertures are slightly over converged; this is corrected by slight outward adjustment of the levers.

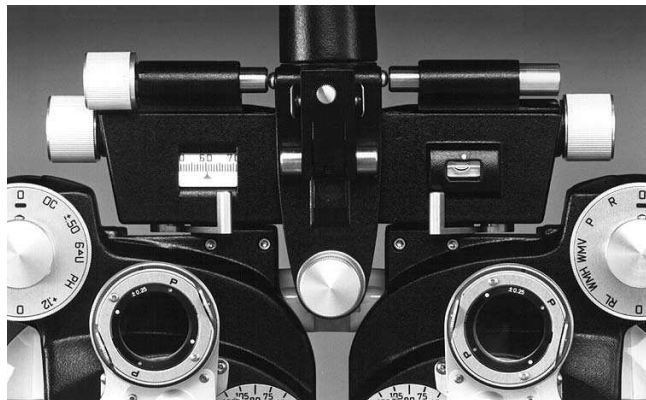

Figure TM-2 Vergence Levers In (Near Tests)

Note: Do not attempt to fully converge the instrument below 55mm distance PD.

Instructions for Use (continued)

Taking Measurements (continued)

Operation of the Sphere Lens Dials

1. All sphere powers, plus and minus, can be introduced into the lens aperture in steps of 0.25D by rotation of a single lens dial, (+0.12D sphere in the Auxiliary Lens Knob can be used to refine the spherical correction to 1/8th D steps.)
2. The operation is simple. Rotation of the Weak Sphere Dial downward (i.e. clockwise for the left eye, counterclockwise for the right eye.) introduces more plus power or less minus. Refer to Figure TM-3.
3. Rotation of the Weak Sphere Dial upward introduces more minus power or less plus. Refer to Figure TM-3.

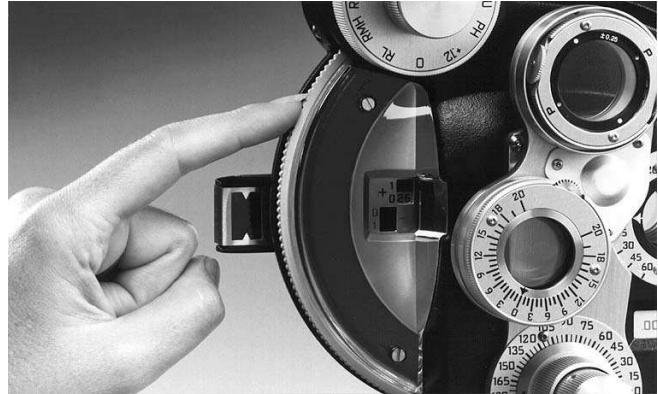

Figure TM-3 Moving Weak Sphere Dial

Note: Plus powers are indicated by black numbers; minus powers, by red numbers.

4. An automatic pick-up system links the two sphere power dials so that whenever a change in power is required in the Strong Sphere Dial, it is automatically moved by the Weak Sphere Dial. Thus, one may dial completely through the +16.75D to -19.00D range in 0.25D steps by rotation of only the Weak Sphere Dial.
5. However, high power may also be introduced quickly and easily by means of the Strong Sphere Control when desired. Refer to Figure TM-4.



Figure TM-4 Rotating Strong Sphere Control (Surrounds Auxiliary Lens Scale)

-continued-

Instructions for Use (continued)

Taking Measurements (continued)

Operation of the Sphere Lens Dials (continued)

6. The Strong Sphere Control introduces sphere power in 3.00D steps and can often be used as a time saver.

Examples:

- To obtain a power of +2.75D (starting from zero), the practitioner could add plus power in quarter diopter steps by rotating the Weak Sphere Dial downward until +2.75D shows on the sphere power scale.
- A quicker way: rotate the Strong Sphere Control nasally one index position to introduce a value of +3.00. Rotate Weak Sphere Dial one index upward to reduce power to +2.75D.
- To obtain a power of +7.00D (starting from zero) the quickest way: rotate Strong Sphere Control nasally two index positions to introduce a value of +6.00D. Rotate Weak Sphere Dial four index positions downward to increase power to +7.00D.
- To obtain a power of -3.50D (starting from zero) the quickest way: rotate Strong Sphere Control temporally one index to introduce a value of -3.00D. Rotate Weak Sphere Dial two index positions upward to increase power to -3.50D.

Taking Measurements (continued)

Cylinder Power and Axis

1. In the Cylinder Lens Dials, which are controlled by turning the Cylinder Power Knobs, the powers range from 0.00 to -6.00D for instruments containing minus cylinders, and from 0.00 to +6.00D for instruments containing plus cylinders.
2. Cylinder power can be changed in steps of 0.25D throughout the full range by means of the Cylinder Power Knob.
3. To increase power, knobs are turned clockwise. Refer to Figure TM-5.
4. A pair of 0.12D cylinders in accessory cells permits refinement to 1/8th D steps.
5. A pair of 2.00D cylinders in accessory cells extends cylinder power range to 8.00D.
6. Large 360° protractors around the Cylinder Axis Knobs mark the position of the axis from 0° to 180° in steps of 5°.
7. The Rx axis reading is taken from the scale at the Cylinder Axis Knob.
8. The axis scale around the aperture is provided for reference during retinoscopy.
9. The Cylinder Axis Knob (concentric with power knob) can be continuously turned clockwise or counterclockwise to set the axis of the cylinder in any meridian from 0° to 180°. Refer to Figure TM-6.

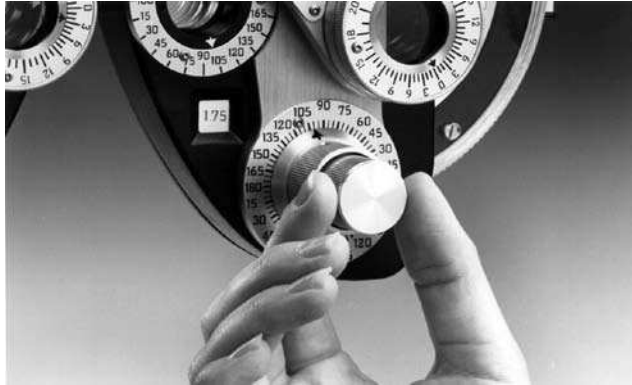

Figure TM-5 Turning Cylinder Power Knob



Figure TM-6 Turning Cylinder Axis Knob

Instructions for Use (continued)

Taking Measurements (continued)

Auxiliary Lens Dial

1. The Auxiliary Lens Dial is controlled by turning the Auxiliary Lens Knob. The Phoropter provides a selection of 10 auxiliary lenses plus two open apertures. Refer to Figure TM-7.
2. Beginning at "O" (open aperture) at the top of the scale, the lenses will index into position in the following order as you turn the Auxiliary Lens Knob clockwise:



Figure TM-7 Auxiliary Lens Scale and Lens Knob

R	Retinoscopic Lens*	+1.50D; low reflection coated. Compensates for working distance during retinoscopy. For example, the standard 1.50D lens compensates for the convenient working distance of 26 inches.
P	Polarizing Lens	For binocular refraction techniques, axis is 45° left eye, 135° right eye.
WMV or RMV	Maddox Rod, Vertical*	White, left eye, red, right eye. For muscle balance tests.
WMH or RMH	Maddox Rod, Horizontal*	White, left eye, red, right eye. For muscle balance tests.
RL	Red Lens	For binocular vision tests.
GL	Green Lens	For binocular vision tests.
O	Open Aperture	Second open aperture provided as a convenience feature. Never have to turn all the way back.
+0.12	+0.12D Sphere	Refines spherical correction to 1/8thD steps.
PH	Pin Hole	Opaque disk with small hole. Used to determine if a patient's vision problem is pathological or a refraction error.
10 △ I or 6 △ U	10 △ base-in left eye 6 △ base-up right eye	Dissociating prisms.
±0.50	±0.50D Fixed Cross Cylinder*	Axis preset for dynamic CC and dissociated CC tests (described in Near Point Rotochart Manual.)
OC's	Occluder	Covers one eye during refraction.

***Note:** Should you wish to substitute special lenses in these positions at some future date, refer to **Replacing Lenses in Auxiliary Dial**, in the **Maintenance** section of this guide.

Instructions for Use (continued)

Taking Measurements (continued)

Rotary Prisms

1. Each Rotary Prism Unit (loupe) has a range of 20Δ .
2. Paired, prisms give 40Δ in any base direction.
3. The scale is marked in broad divisions of one prism diopter (Δ).
4. The Rotary Prism Unit and the Cross Cylinder Unit are attached to the Turret Assembly. The Turret Assembly rotates to locate either the Rotary Prism Unit or the Cross Cylinder Unit in front of the patient's eye. When testing for prism rotate the Rotary Prism Unit in front of the eye. With the Rotary Prism Unit in front of the patient's eye, the unit can be oriented to determine base up, base down, base in, or base out prism. Refer to Figure IU-6.

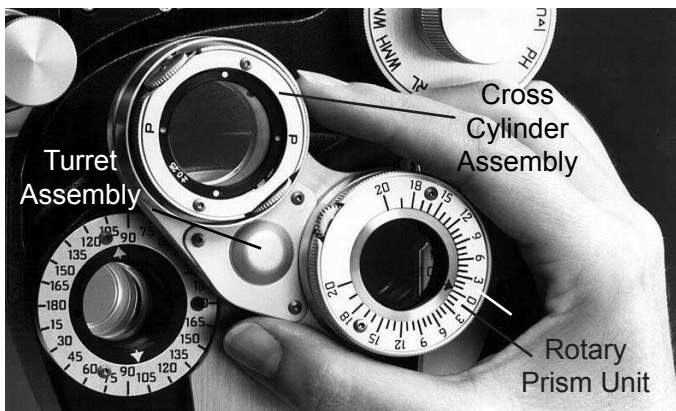

Figure IU-6 Finger Roll Knob



Figure IU-7 Rotary Prism Unit

5. The Finger Roll Knob rotates the prism lenses inside the Rotary Prism Unit and varies the magnitude of prism. Refer to Figure IU-7.
 - When the Finger Roll Knob is located at either the top or bottom of the Rotary Prism Unit, the prism change will be base in or base out as the Finger Roll Knob is rotated.
 - When the Finger Roll Knob is located on either the left or right side of the Rotary Prism Unit, the prism change will be base up or base down as the Finger Roll Knob is rotated.

Note: With the Rotary Prism set for introducing base in or base out prism, the arrowhead positioned nasally from 0Δ denotes base in prism.

Instructions for Use (continued)

Taking Measurements (continued)

Cross Cylinders

1. The standard cross cylinder cells supplied are +0.25D. These cells are removable and +0.37D and +0.50D are available and may be substituted.
2. The power of the cross cylinder is engraved on the cell.
3. Red dots indicate the minus axis, and white dots the plus axis.
4. A thumb-operated Roll Knob provides for rapid “flipping” of cross cylinders. Refer to Figure IU-8.

Note: The simplified, synchronized action of the Cross Cylinder Unit is described in this manual under “Jackson Cross Cylinder Tests” in the next section.

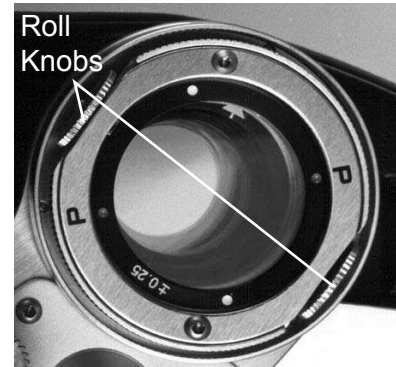

Figure IU-8 Cross Cylinder Unit

Jackson Cross Cylinder Tests

One of the unique features of the Phoropter is that the Cross Cylinder Unit (loupe) lenses are geared together with the correcting cylinder test lenses so that when a change in axis is made in the latter, a corresponding change will automatically occur in the axis of the cross cylinder lenses. This feature relieves the practitioner of the necessity of manually changing the cross cylinder axis each time the correcting cylinder axis is changed.

Note: Because most practitioners prefer to check cylinder axis before checking cylinder power, the procedure is written in this sequence. If you prefer to check power first, reverse the sequence and perform a final power check after the axis check.

Procedure

1. With the tentative sphere and correcting cylinder (determined by retinoscopy and/or the astigmatic chart) in place, the Cross Cylinder Unit is positioned before the aperture of the eye being tested.
2. The patient fixates on the smallest line of legible letters.

Axis Check

1. The Cross Cylinder Unit is in the correct position for axis check when the axis of the Finger Roll Knobs (handles) correspond to the axis of the correcting cylinder and the red and white dots are 45° from the correcting cylinder axis. Refer to Figure JC-1.

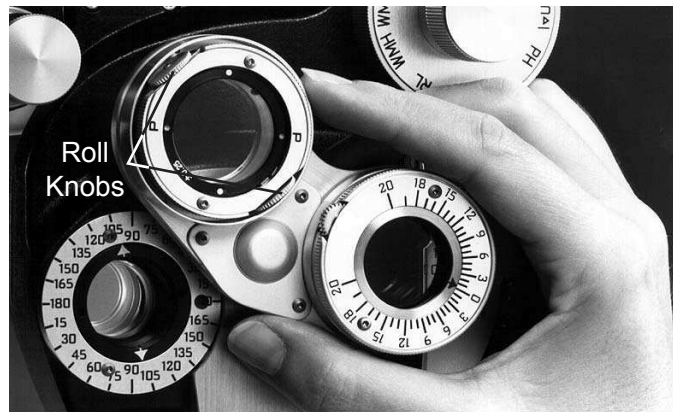

Figure JC-1 Finger Roll Knob

2. Rotate the Turret Assembly to position the Cross Cylinder Unit in front of the main aperture (Roll Knobs should correspond to the axis of the correcting cylinder).
3. If the cross cylinder is not in the correct position (i.e. axis 45° from the correcting cylinder axis), the practitioner need only rotate the Cross Cylinder Unit 45° counterclockwise to de-cent.

-continued-

Instructions for Use (continued)

Jackson Cross Cylinder Tests (continued)

Procedure (continued)

Axis Check (continued)

4. The axis check test is performed in the usual manner with the cross cylinder lens flipped from position I to position II. Refer to Figures JC-2.
 - a. If vision is improved in one position, but made worse in the other position, the minus* correcting cylinder axis is rotated toward the position of the red dots in which vision is improved.

Note: As the correcting cylinder axis is rotated, the cross cylinder axis is automatically rotated a corresponding amount. Hence, the practitioner does not have to manually rotate the cross cylinder the same amount as the correcting cylinder for the subsequent rechecks.

- b. Again, recheck for axis following any modification made in the correcting cylinder axis and by following procedure as in (a) until final end-point is reached.
- c. End-point is reached (i.e. correcting cylinder axis is correct) when vision is equally impaired by flipping cross cylinder lens from position I to position II.

Power Check

1. To reach the power check position from axis check, the practitioner merely rotates the unit clockwise to the next detent position. Visual confirmation of the correct power check position finds the white dots, or the red dots and letters "P" (for power) on the cross cylinder. Refer to Figure JC-4.

Note: Set Cross Cylinder Unit for power check ("P's" on cylinder unit should be parallel to correcting cylinder axis.)

*When plus, instead of minus, correcting cylinders are used, attention is given to the white dots, instead of the red dots on the cross cylinder lens.

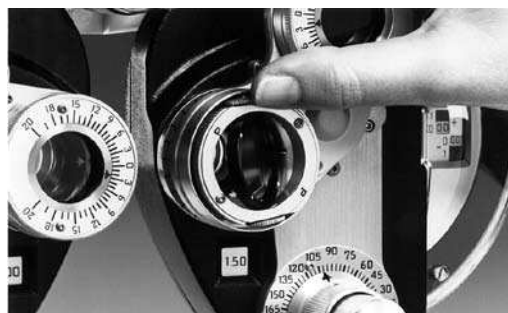

Figure JC-2 Flip Cross Cylinder



Figure JC-3 Reset Axis



Figure JC-4 Power Check

Jackson Cross Cylinder Tests (continued)

Procedure (continued)

Power Check (continued)

2. Since the cross cylinder is in the axis check position, the practitioner merely rotates the unit 45° clockwise to the detent for proper power check positioning. The power check test is performed in the usual manner with the cross cylinder lens flipped from position I to position II. Refer to Figures JC-5 and JC-6.
 - a. If vision is better with red dots parallel to correcting minus* cylinder axis, power of correcting cylinder is increased.
 - b. If vision is better with red dots perpendicular to correcting minus* cylinder axis, power of correcting cylinder is reduced.
 - c. End-point is obtained (i.e. correcting cylinder power is correct) when vision is equally impaired by flipping cross cylinder lens from Position I to Position II.
3. At the end of each refraction, the Cross Cylinder Unit should be rotated 45° counterclockwise to the detent so that for the next refraction the cross cylinder axis will be positioned 45° from the correcting cylinder axis (i.e. Thumb Roll Knobs parallel to arrows on axis knobs). This presets the instrument for the axis check during the next refraction.



Figure JC-5 Adjust Power



Figure JC-6 Rotate Cross Cylinder

*When plus, instead of minus, correcting cylinders are used, attention is given to the white dots, instead of the red dots on the cross cylinder lens.

Cleaning & Maintenance

To keep your Phoroceptor in perfect operational condition and add to instrument life, review this section of the instruction manual carefully. It will aid you in performing a few basic servicing tasks and help you derive full value from your instrument.

CAUTION: IN ORDER TO KEEP THE LIMITED LIFETIME WARRANTY CURRENT, THE PHOROCEPTOR MUST BE SENT IN FOR CLEANING TO REICHERT OR A REICHERT AUTHORIZED DEALER FOR CLEANING ONCE EVERY THREE YEARS.

Cleaning

Make it a habit to always keep your Phoroceptor covered when it is not in use. The Dust Cover provided will aid in keeping lenses clean and keep dust from working inside the instrument and eventually contaminating the lubricant. Keep the exterior surfaces clean by periodically wiping it with a clean, dry cloth. If there are stains that are hard to remove, moisten the soft cloth with a mild soap solution (1 cc of liquid dish soap to one liter of clean, filtered water (filtered below 5 microns)).

CAUTION: DO NOT DRIP ANY FLUIDS INTO THE PHOROCEPTOR OR DAMAGE TO THE INSTRUMENT MAY OCCUR.

CAUTION: DO NOT USE ALCOHOL OR ACETONE. STRONG SOLVENTS CAN DAMAGE THE FINISH.

Note: All lens disc apertures are “open” when the Sphere Power Scale and Cylinder Power Scale read zero and the Auxiliary Lens Dial Knob is set at “0”.

CAUTION: DO NOT TEST FOR AN OPEN APERTURE BY INSERTING FINGERS IN THE APERTURE AS LENS SURFACES CONTACTED WILL BE SOILED.

Sanitary Face Shields

The semi-permanent Face Shields furnished with the Phoroceptor are made of white nylon and have a protective lens on them to help keep the inside of the Phoroceptor free of contaminants. This material can be washed with a mild soap solution (1 cc of liquid dish soap to one liter of clean, filtered water (filtered below 5 microns)), or wiped with alcohol.

Note: If using alcohol, be careful not to soak the lens, and the area where the lens is attached to the plastic. The alcohol may weaken the glue, causing the lens to fall out.

Note: Do not press hard on the glass when cleaning. This may cause the lens to fall out, or fall into the Phoroceptor.

Cleaning the Lenses

All lenses should be kept clean and free of dust, fingerprints, etc. How rapidly lenses become soiled depends on many factors; whether the office has air conditioning or windows are opened for ventilation, adjacency of industry, humidity, etc.

Suggestions are offered here for the self-cleaning of lenses. It is advisable, however, to have the lenses cleaned approximately once a year by a Reichert authorized Dealer. It is generally good preventative maintenance to have mechanical assemblies cleaned and re-lubricated at the same time.

There are protective lenses on the front (doctor's) side of the Phoroceptor in both the left and right apertures. These lenses are held in place by a rubber O ring, and should be removed before cleaning the internal lenses. Clean these lenses before inserting them back in the Phoroceptor with the following procedure.

-continued-

Cleaning & Maintenance (continued)

Cleaning (continued)

Cleaning the Lenses (continued)

1. In a thorough cleaning procedure, there are a total of 168 lens surfaces to be cleaned. Lens surfaces can be reached for cleaning through the front or rear instrument apertures and it should not be necessary to separate the dials.

Note: A common rubber ear syringe will be found useful in blowing dust from lens surfaces.

2. Use caution to keep the syringe clean so that it will not soil lens surfaces which it may accidentally touch. If dust persists, then a careful, light brushing of the lens surface with a camel's hair brush followed by syringe action will often prove helpful.
3. For complete cleaning of lenses, a soft surfaced cleaning tool is desirable. An efficient cleaner can be fashioned by rolling a strip of soft, lint-free linen around a slim, soft-wood stick so that a roll of cloth about 3/16" - 1/4" in diameter with a flat end is formed. The cloth should project beyond the end of the supporting stick. As the cleaning end of this tool becomes soiled, clip the soiled end with scissors to expose a new clean surface or reroll with fresh cloth. Slightly moistening the tip of this tool with lens cleaning solution is desirable.
4. Indirect illumination from a standard lamp bulb through the instrument apertures will help identify soiled lenses. Lenses may be cleaned with the Phoroceptor in place on the instrument stand for easiest handling or the instrument may be removed and supported on a sturdy, padded table.

Cleaning Procedure

1. Rotate the Turret Assembly so no loupes are in front of viewing apertures.
2. Set all scales at zero or open.
3. Adjust PD to its extreme position (75 mm.)
4. Set the instrument for distance (unconverged.)
5. Clean lenses by dialing the following lens powers into position consecutively and cleaning both front and back lens surface as each one is brought to the aperture:
 - a. Cylinder powers:

.25	.50	.75	1.00
1.25	2.50	3.75	5.00
 - b. Return Cylinder Power Scale to zero.
 - c. Sphere powers (by rotating the knurled dial):

+1.75	+1.50	+1.25	+1.00
+.75	+.50	+.25	-.25
-.50	-.75	-1.00	
 - d. Return Sphere Power Scale to zero.
 - e. Sphere powers (by rotating the strong sphere control):

+3.00	+6.00	+9.00	+12.00
+15.00	-18.00	-15.00	-12.00
-9.00	-6.00	-3.00	
 - f. Return Sphere Power Scale to zero.
 - g. Auxiliary Lens Dial (by positioning Auxiliary Selector Knob):

Retinoscopic	Polarizing (Analyzer)
Maddox Rod	Maddox Rod
Vertical	Horizontal
Red Filter	+0.12 Sphere
Fixed Cross Cylinder	Dissociating Prism
 - h. Now clean front and rear surfaces (exposed surfaces only) of the Rotary Prism Loupe, Cross Cylinder Loupe, and lenses in the accessory case.

Lens Replacement

Replacing Lenses in Auxiliary Dial - Old Style Phoroptors

Five lenses in each dial are cell mounted: the retinoscopic, polarizing, both Maddox rods, and fixed cross cylinder lenses are in individual cells permitting **substitution** of special lenses. Two washers and screws retain each cell. Refer to Figure MM-5.

To remove cell from dial:

1. Turn the Auxiliary Dial Knob until one of the two retaining screws is visible in the rear of the main aperture.
2. Turn the screw 1/4 turn counterclockwise- **do not remove**- until the washer can be rotated to place the flat side of washer toward the cell.
3. Gently retighten the screw.
4. Turn the knob until the other screw and washer are visible in the aperture.
5. Repeat the preceding step.
6. Next, turn the knob to center the cell in the aperture.
7. Gently press the cell out of the auxiliary dial thru the rear of the aperture.
8. The procedure is reversed to install a new cell mounted auxiliary lens.
9. Make certain that the “notches” in the cell are positioned to permit entry of retaining washers.
10. To lock new cell into position: turn the screw 1/4 turn; rotate washer so that flat side is 90° away from cell; tighten the screw firmly.
11. Repeat for the other screw and washer.

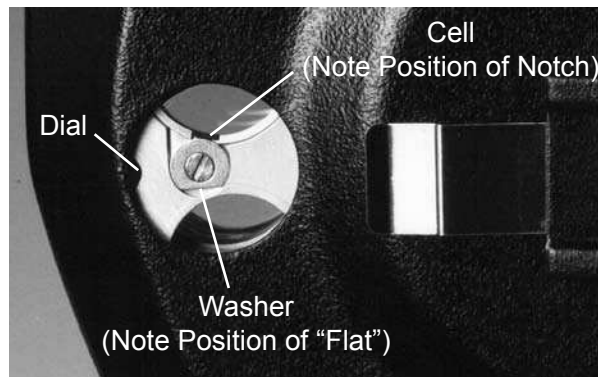

Figure MM-5 Auxiliary Dial - Old Style
(Removable Cell Viewed Through
Rear of Main Aperture.)

Replacing Lenses in Auxiliary Dial - New Style Phoroptors

New style Phoroptors do not have washers. The washer and screw is replaced by a single, magnetized screw. Refer to Figure MM-6.

To remove cell from dial:

1. Turn the Auxiliary Dial Knob until one of the two retaining screws is visible in the rear of the main aperture.
2. Unscrew the retaining screw and remove it.
3. Turn the knob until the other screw is visible in the aperture.
4. Repeat the preceding step.
5. Next, turn the knob to center the cell in the aperture.
6. Gently press the cell out of the auxiliary dial thru the rear of the aperture.
7. The procedure is reversed to install a new cell mounted auxiliary lens.
8. To lock new cell into position, tighten the screw firmly.
9. Repeat for the other screw.

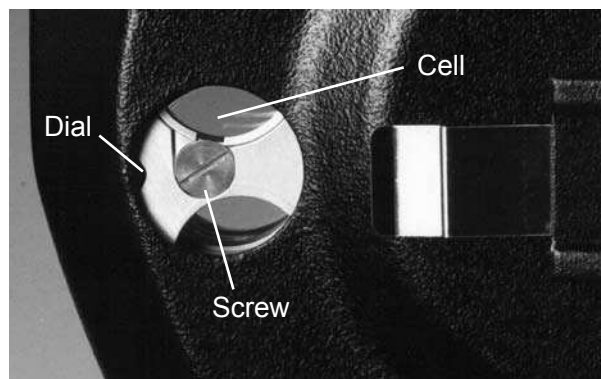

Figure MM-6 Auxiliary Dial - New Style
(Removable Cell Viewed Through
Rear of Main Aperture.)

Cleaning & Maintenance (continued)

Lens Replacement (continued)

Changing Cross Cylinder Lens Assembly

The cross cylinder is changed as a complete assembly. Follow the procedure below and refer to Figures MM-1, and MM-2.

1. Using a 0.060-6 Spline Screwdriver, remove the two spline screws.
2. Lift off the retaining ring.
3. Lift out the complete Cross Cylinder Lens Assembly.
4. Reverse the procedure to install a new cross cylinder.

Note: Assembly is symmetrical so either side can face outward.



Figure MM-1 Cross Cylinder Lens Assembly

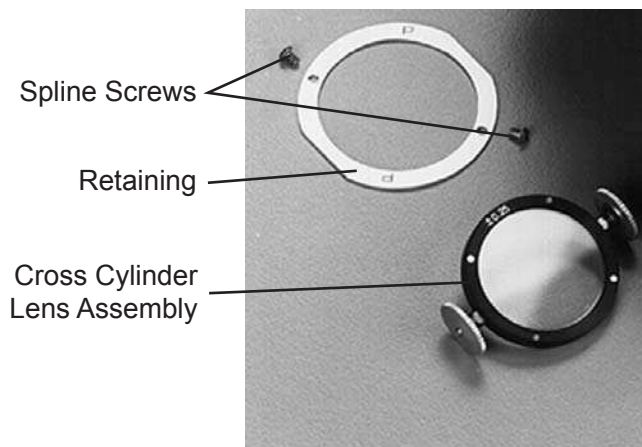

Figure MM-2 Cross Cylinder Lens Assembly Close Up

Adjustments

Adjusting Tension of Hinged Reading Rod Holder

The Reading Rod Holder is held in the stored position by a spring clip. The Rod Hinge contains two pins which engage into the clip when moved to the vertical position.

The Reading Rod Hinge is under tension. Occasionally you may want to readjust this tension. To do so:

1. Hold one of the slotted head nuts with a screwdriver.
2. With a second screwdriver tighten the other nut. Refer to Figure MM-3.
3. Periodically the bearing which secures the Reading Rod Holder requires lubrication. Move the holder to the down position for accessibility to oil the hole and add a drop or two of light oil.

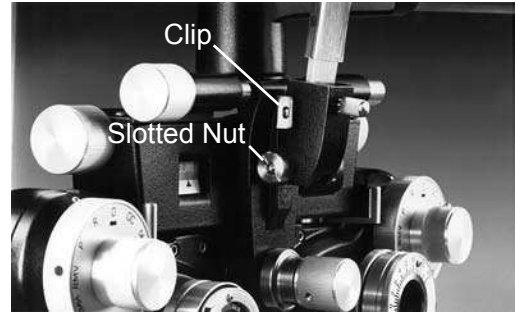

Figure MM-3 Cross Cylinder Lens Assembly

Adjustment of Dial Rotation Tension

The sphere lens system, cylinder lens system, and auxiliary lens system all have rolling Index Wheels. The pressure of the wheel in the dial index determines, to a considerable degree, the “feel” of the dial rotation and indexing.

Each may be adjusted from the outside of the instrument with no dismantling required.

Refer to Figure MM-4 to see the adjusting screws positioned at the bottom of the lens housings.

1. The screw in front, or cylinder section, controls indexing tension of the cylinder power mechanism.
2. The center screw of the three which is in the forward portion of the rear, or sphere section, controls indexing tension of the sphere power mechanism.
3. The screw in the back portion of the rear, or sphere section, controls indexing tension of the auxiliary lens mechanism.

Note: A standard 5/64” Allen wrench is used.

4. In each case, clockwise rotation of the adjusting screw increases indexing tension and counter-clockwise rotation reduces indexing tension.

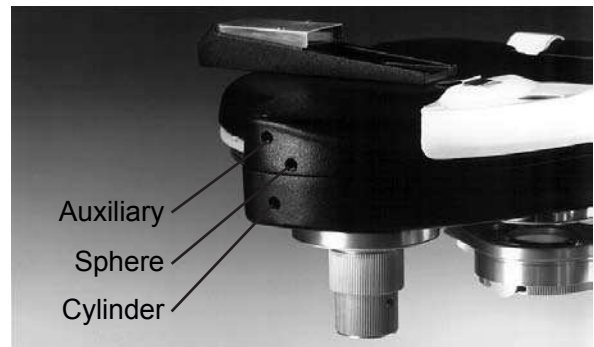

Figure MM-4 Dial Rotation Tension

Troubleshooting

Due to the Phoroceptor being enclosed and the mechanical nature of the unit, problems associated with the Phoroceptor should be handled by trained Reichert personnel. Please contact Reichert customer service with the contact information located in the **Introduction** section of this manual, or on the back cover.

For user serviceable problems, please consult the following list:

Light Does Not Turn On. (Illuminated Phoroceptor Only.)	Check to see if the male connector is properly inserted into the female connector on the mounting bracket.
	Ensure that the power adaptor is installed into an outlet with the correct input voltage.
	Light may be turned all the way down. Turn the Rheostat Control knob all the way up.
Weak Sphere Dial Too Loose or Tight.	Tighten or loosen the coordinating screw on the bottom of the phoroceptor using a standard Allen wrench (not provided.) Be careful not to adjust the screw too tight or too loose. Refer to the <u>Maintenance</u> section.
Cylinder Power Knob Too Loose or Tight.	Tighten or loosen the coordinating screw on the bottom of the phoroceptor using a standard Allen wrench (not provided.) Be careful not to adjust the screw too tight or too loose. Refer to the <u>Maintenance</u> section.
Auxiliary Lens Scale Too Loose or Tight.	Tighten or loosen the coordinating screw on the bottom of the phoroceptor using a standard Allen wrench (not provided.) Be careful not to adjust the screw too tight or too loose. Refer to the <u>Maintenance</u> section.

Specifications

Catalog Number 11625 / 11636

Physical Dimensions			
Size:		Weight, unpacked: 9.5 lbs. (4.3 Kg)	
Height: 11.56 in. (29.36 cm)			
Width: 12.75 in (32.38 cm)			
Depth: 3.90 in (9.91 cm)			
Specifications	Range	Steps/ Graduations	Additional Information
Sphere:	-19.00 to +16.75	0.25D	+0.12 Sphere in auxiliary dial included.
Cylinder:	0.00 to 6.00	0.25D	5°
Cylinder Axis:	360 ° (double 180 °scale.)	5°	
Cross Cylinder:	±0.25D		±0.37 or ±0.50 Optional
Prism:	0 to 20 Prism Diopters	1 Prism Diopter	
P.D.:	48mm to 75mm	1mm	
Vertex Distance:	13.75mm normal		Graduations extend range by 6mm.
Reading Distance:	5" to 28"		Centimeter and diopter scales included.
Auxiliary Dial:	10 lenses plus 2 open apertures		
Electrical (Illuminated Phoroceptor Only)			
Power Adaptor			
Input Voltage: 100-240 VAC			
Input Frequency: 50/60 Hz			
Output Voltage: 5.0 Vdc			
Output Current: 4.0-7.0 VA			
Operational Conditions			
Environmental: The environmental conditions are as follows:			
Operating:			
Temperature: 10° to 35 °C (50° to 95 °F)			
Relative Air Humidity: 30% to 75%			
Atmospheric Pressure: 80 kPa (23.6 in. Hg) to 106 kPa (31.3 in. Hg)			
Transportation & Storage:			
Temperature: -20° to 60 °C (-4° to 140 °F)			
Relative Air Humidity: 10% to 80% (non-condensing)			
Atmospheric Pressure: 50 kPa (14.8 in. Hg) to 106 kPa (31.3 in. Hg)			
Exposure to extreme temperature conditions indicated above must not exceed 15 weeks.			

Specifications (continued)

Storage Conditions

Always place the Dust Cover on the Phoroceptor when not in use to ensure that dust and other contaminants do not get inside the unit. Over time, the presence of dust and other contaminants inside the unit may affect operation of the Phoroceptor.

Disposal

For proper disposal or recycling purposes, Reichert will take back the Phoroceptor. Please contact Reichert. The Phoroceptor must not be disposed of with residential waste.

Warranty

**This warranty supersedes any other warranty for Phoroceptors purchased on or after 11/1/2001
Please keep this information for your records.**

What and Who is Covered

The Phoroceptor is warranted to be free from material and workmanship defects, under normal use, for as long as the original purchaser owns the instrument. A dealer shall not be considered an original purchaser. This warranty applies to all new products purchased after November 1, 2001.

What is Required of the Purchaser

Product registration (or possession of original receipt) and proof of regular instrument service (performed by Reichert or by an authorized Reichert dealer) are required for any claim under the limited lifetime warranty. Regular instrument service must be performed at least every three years and is defined as, at a minimum, thorough evaluation of all mechanisms, cleaning in accordance with Reichert approved procedures, and lubrication and adjustment as required. Product registration can be accomplished via mail, fax, or Internet (www.reichert.com). Records of service performed by Reichert will be maintained for the customer at the factory. Records of service performed by an authorized Reichert dealer must be maintained by the customer.

What is not Covered

Cleaning and lubrication are required on a regular basis and are not covered under this warranty; nor are dust covers, face shields, and other consumable items; nor does this warranty apply to product which has been tampered with, altered in any way, misused, damaged by accident or negligence, or which has the serial number altered or removed; nor shall this warranty be extended to a product installed or operated in a manner not in accordance with the Reichert instruction manual; nor to a product that has been sold, serviced, installed or repaired other than by Reichert or by an authorized Reichert Ophthalmic Instrument Dealer. Furthermore, Reichert shall not be liable for costs of procurement of substitute goods by anyone.

How to File a Claim

Any claim under this warranty must be made within 30 days of the failure. Warranty claims for Phoroceptors up to 1 year old should be filed with the dealer from whom the instrument was purchased. Warranty claims for Phoroceptors older than 1 year must be filed directly with Reichert, Inc. via phone, fax, or email. The customer will obtain a Return Material Authorization ("RMA") number from Reichert prior to returning the product freight prepaid. Instruments returned to Reichert for warranty service must be accompanied by a copy of the purchaser's original invoice and proof of regular instrument service as defined above. Reichert will pay for transporting the repaired or exchanged product back to the customer. Repaired, replaced, or exchanged product will be warranted for the remainder of the original warranty.

Limitations

Reichert's sole obligation under this warranty is to repair or replace the defective part or product at Reichert's discretion and at Reichert's cost. This warranty is in lieu of all other warranties implied or expressed. All implied warranties of merchantability or fitness for a particular use are hereby disclaimed. No representative or other person is authorized to make any other obligations for Reichert. Reichert shall not be liable for any special, incidental, or consequent damages or for any negligence, breach of warranty, strict liability or any other damages resulting from or relating to design, manufacture, sale, use, or handling of the product.

Exceptions to Limitations

Some states/countries do not allow the exclusion or limitation of incidental or consequential damages. Furthermore, some states/countries do not allow limitations on how long an implied warranty lasts. As such, some of the limitations set forth in this warranty may not apply to you. This warranty gives you specific legal rights, and you may also have other rights that vary from state to state and country to country.

www.mercoframes.com



MERCOFRAMES